

Outline

- PICO superheated liquid technology
- PICO Background Mitigation
- Recent Results from PICO 60
- Future Plans: PICO 40 → PICO 500

Results and Future Plans for the PICO Dark Matter Bubble Chamber

Tony Noble
Queen's University

The Bubble Chamber Technology

Bubble Chamber Operation

Phase diagram

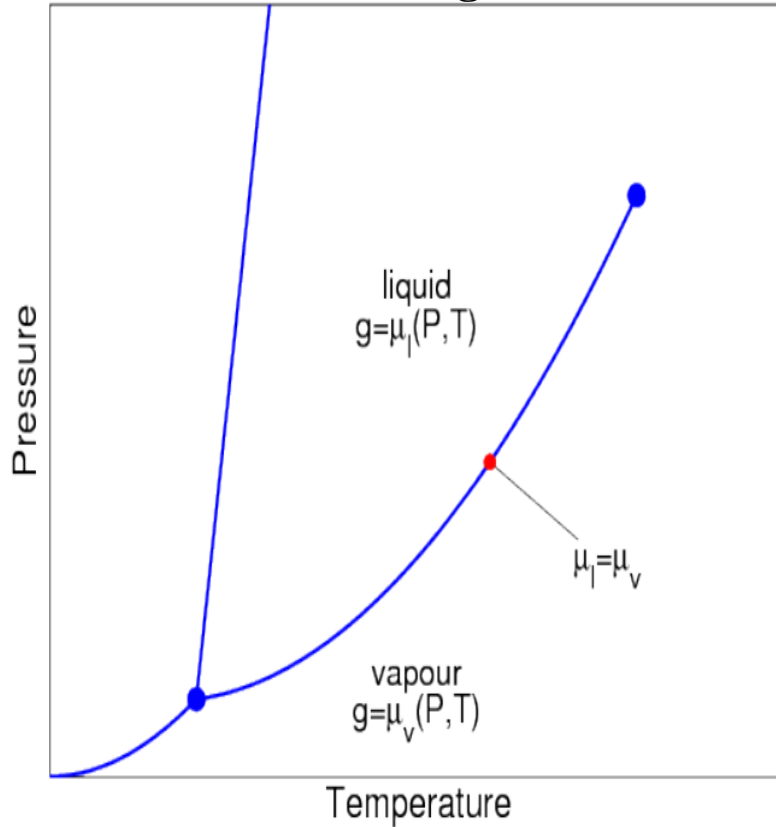

Gibbs free energy

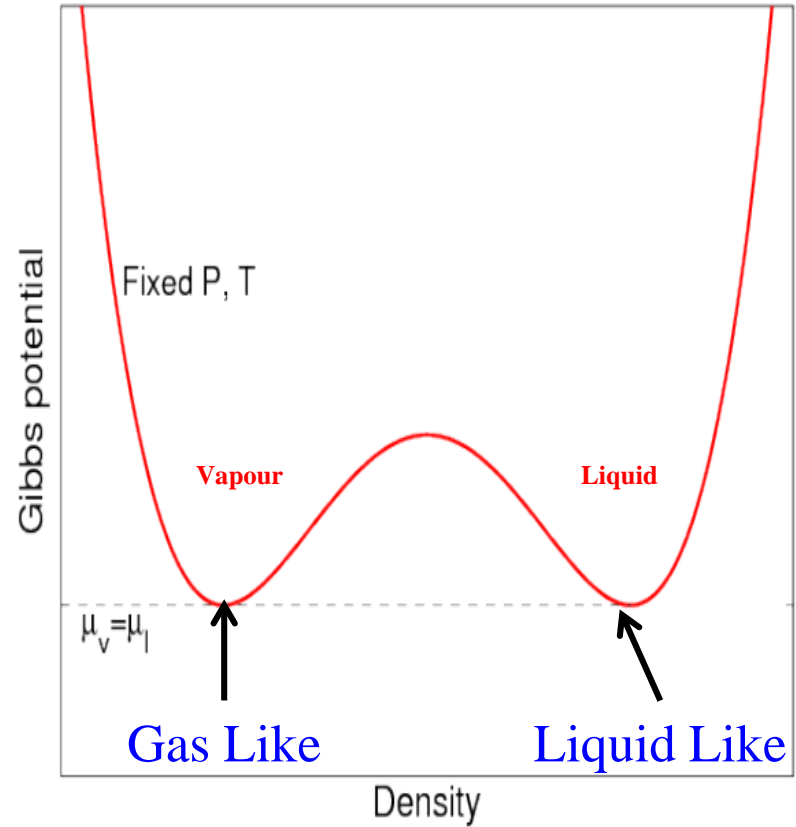

When on the saturation curve, liquid and gas are in equilibrium. (Same pressure, temperature and chemical potential).

At equilibrium, the potential has two minima (one dominantly gas like and one liquid dominated)

Bubble Chamber Operation

Phase diagram

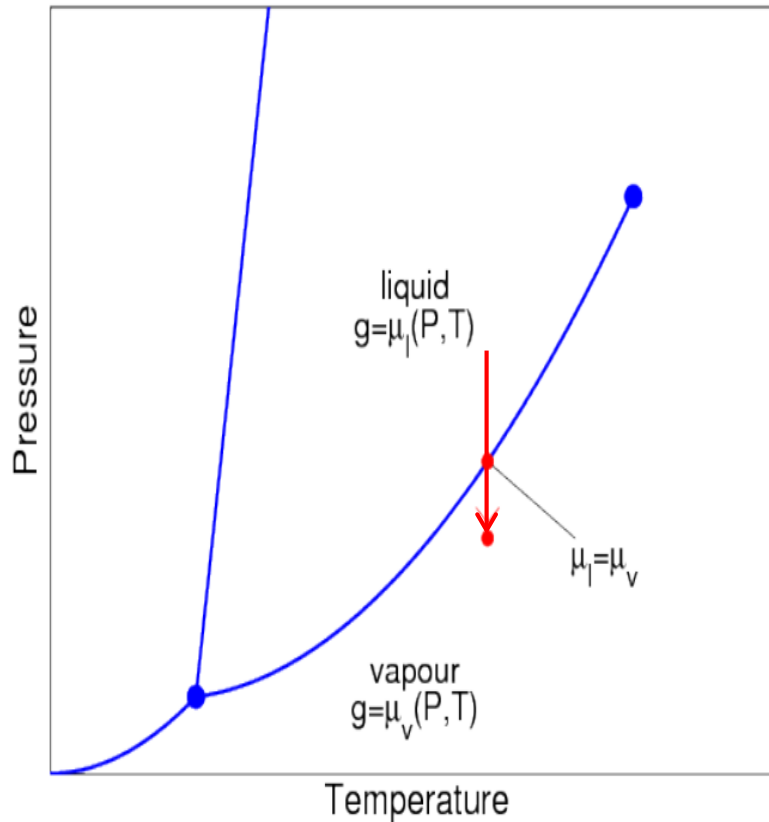

Gibbs free energy

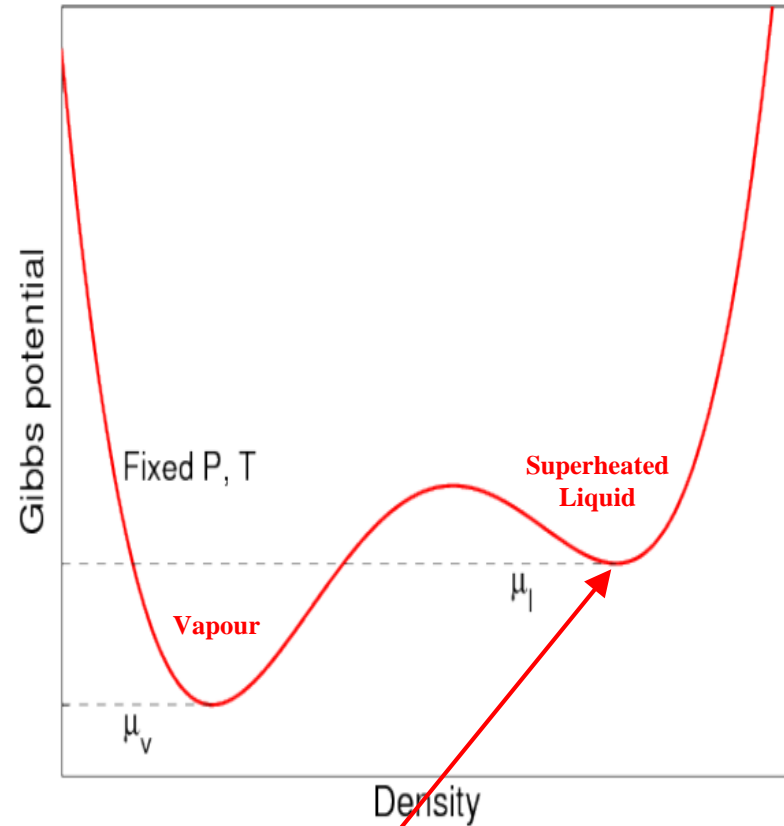

We now lower the pressure of the chamber carefully....starting from the pure liquid phase.

This distorts the potential, leading to a **meta-stable** superheated liquid state. Unless sufficient energy is added, it will stay in meta-stable state.

Particle detection with bubble chambers

- A bubble chamber is filled with a superheated fluid in meta-stable state.
- Energy deposition greater than E_{th} in radius less than r_c from particle interaction will result in expanding bubble (*Seitz “Hot-Spike” Model*).

$$E_{th} = 4\pi r_c^2 \left(\sigma - T \frac{\partial \sigma}{\partial T} \right) + \frac{4}{3} \pi r_c^3 \rho_v h$$

Surface energy

Latent heat

- A smaller or more diffuse energy deposit will create a bubble that immediately collapses.

Take away message:

- To be sensitive, particle must deposit enough energy within a critical radius.

Principle of Operation: Original Bubble Chambers

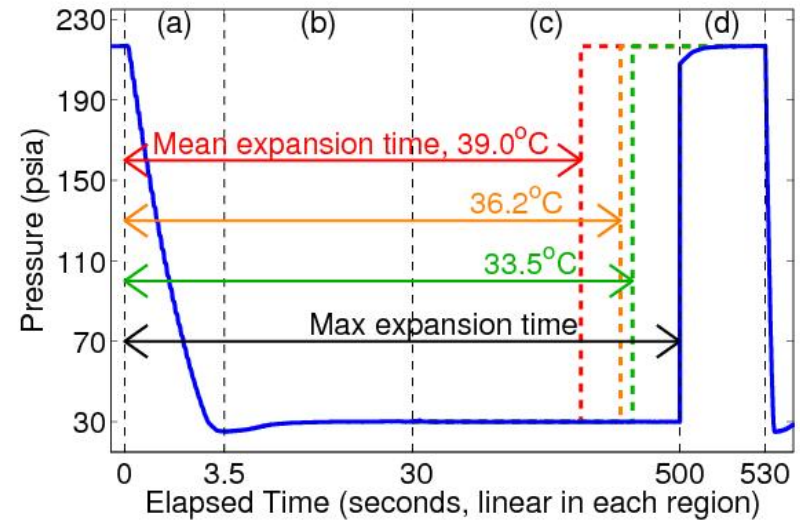
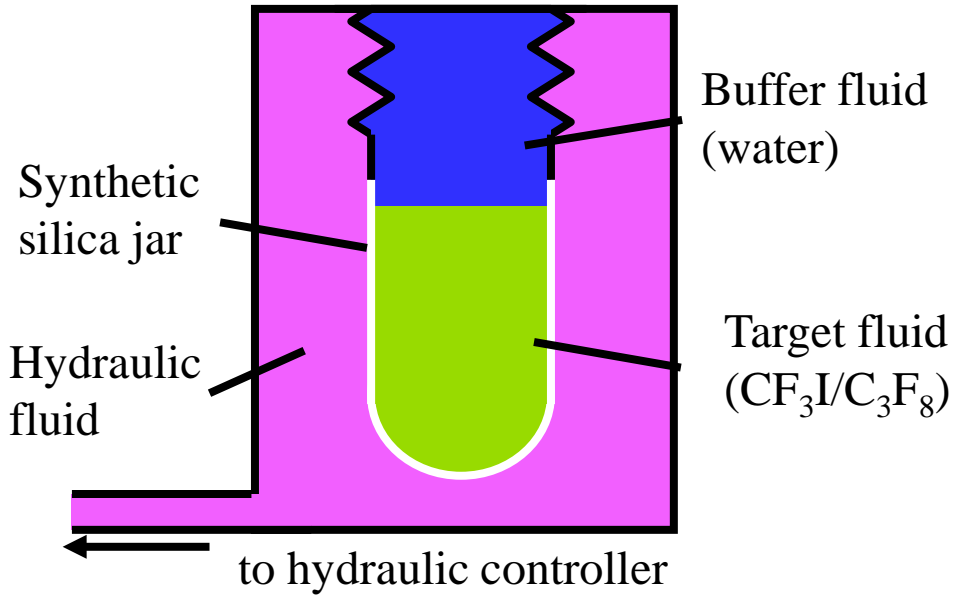

1. Lower the pressure to a superheated state.

2. See the bubble:

- Cameras trigger. record position, multiplicity
- Microphones record acoustic trace
- Fast pressure transducer recording.

3. Raise pressure to stop bubble growth (100ms), reset chamber (30sec)

Run: 20131108_7 Event: 10

Event Time: Fri Nov 8 14:15:00 2013

Current Time: Tue Jun 10 11:25:53 2014

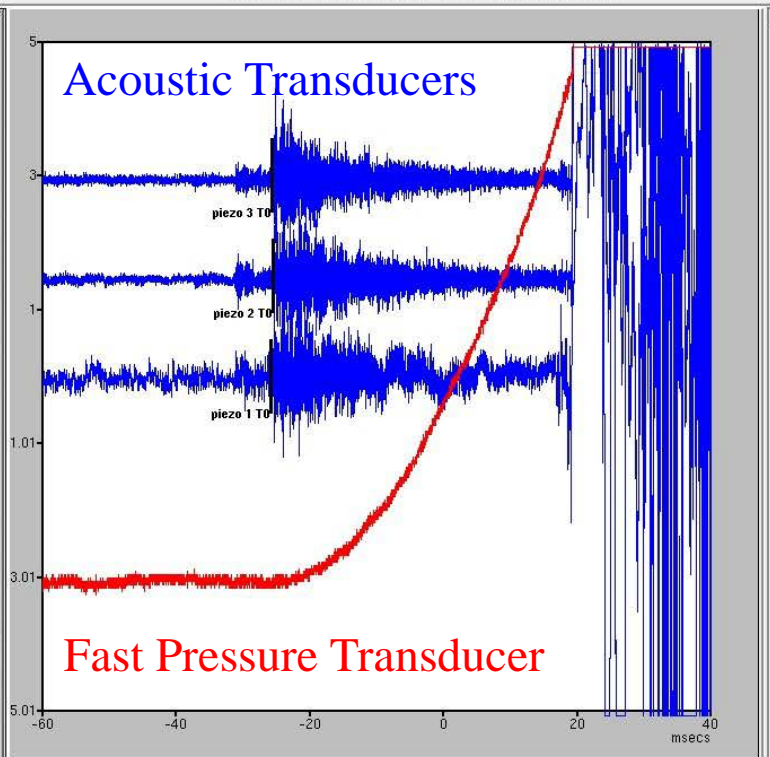
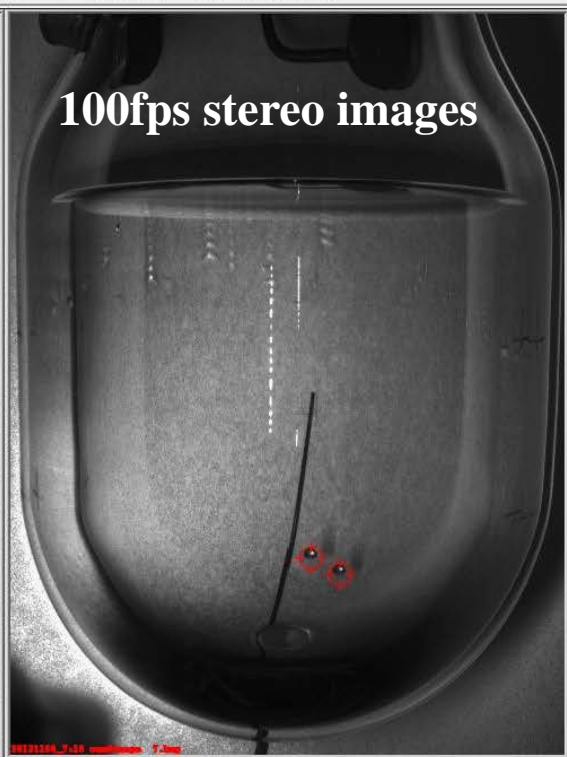
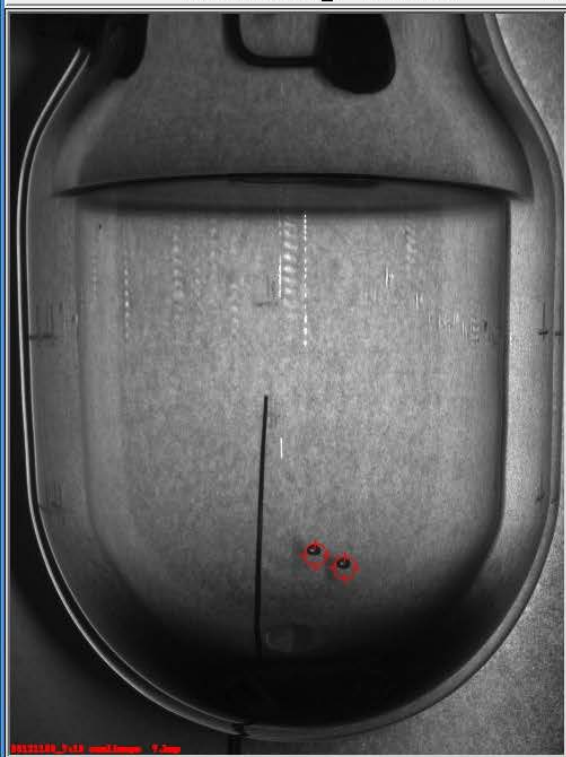

Time run start: Fri Nov 8 13:49:15 2013 this event: Fri Nov 8 14:15:00 2013 msec time: 3301294483	Pressure [PSIA] PT0: 32.66 PT1: 194.37 PT2: 31.64 PT3: 30.01 PT4: 31.28 setpoint: 30	Pressure Ramp	Temperature [degC] TD: 14.26 T1: 14.4 T2: 12.83 T3: 12.68	Event Timing [s] expanded time: 106 live time: 114.08	Frame Timing [ms] Time between frames [ms] 1-0 2-1 3-2 4-3 5-4 6-5 7-6 8-7 9-8 cam0: 11 10 9 10 11 10 10 9 10 cam1: 11 10 9 10 11 10 10 9 10 cam1 frame0 - cam0 frame0: 0 # skipped frames cam0: 0 cam1: 0	Pixels # hit pixels 0 1 2 3 4 5 6 7 8 9 cam0: 0 0 0 0 25 116 167 236 390 854 cam1: 0 0 0 0 44 158 253 414 523 584	Misc. trigger type: main=0, ctic=12, plc=1, slow=0 run type: 1 (neutron calib) data series: 2I-13 DAQ version: PICO2L:1.0	
Bubble Recon Bubble frame (cam0,cam1): (4,4) Bubble count (cam0,cam1): (2,2) Bub 1: ((0,0): (290.5, 160.5)) _ (1,1): (295.1, 166)		Dytran Analysis dytran2_type: 0(wall/other) dytran2_bubnum: 2.38 Quadratic Fit Cubic Fit		Acoustics Acoustic Parameter: 2.480 Acoustic Parameter (3 band): 2.872 Channels Used: 7(1,2,3)		Trigger Times TO Piezo 1: -0.0258744 TO Piezo 2: -0.0255704 TO Piezo 3: -0.0256452		Misc analysis version: R3-13 recon event type: spurious video
Bubble frame (cam0,cam1): (4,4) Bubble count (cam0,cam1): (2,2)		dytran2_type: 0(wall/other) dytran2_bubnum: 2.38		Acoustic Parameter: 2.480 Acoustic Parameter (3 band): 2.872		analysis version: R3-13 recon event type: spurious video		Bubble frame (cam0,cam1): Bubble count (cam0,cam1):

Screen Display during operations

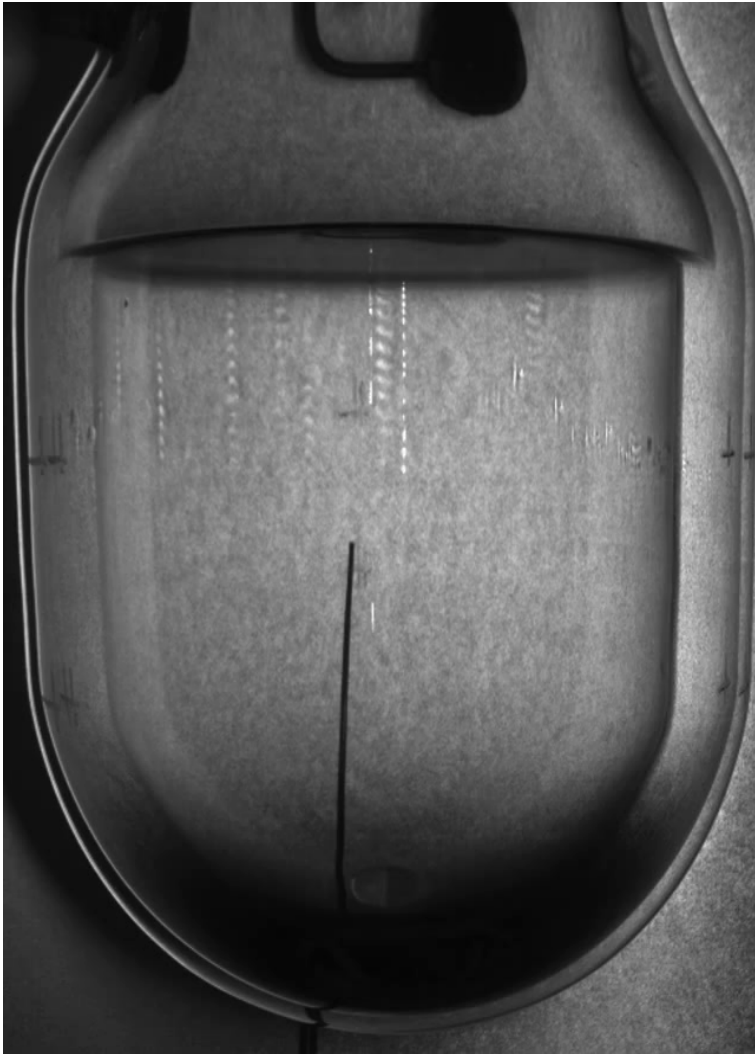

Single Bubble event

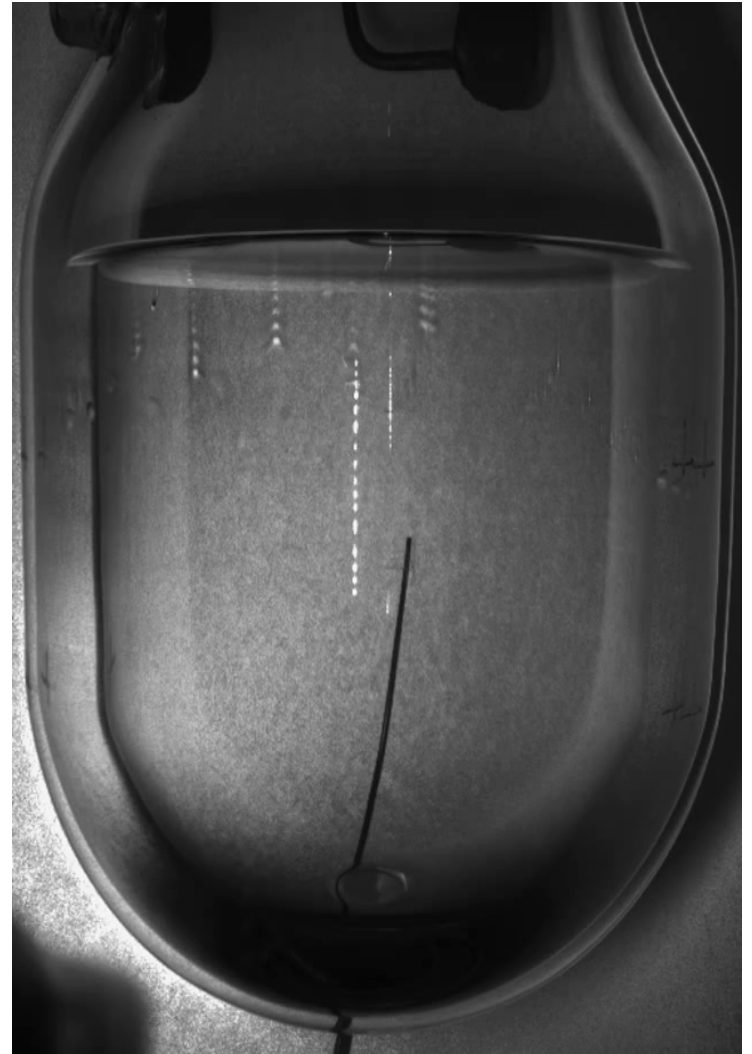

Neutron event

Background Mitigation:

Backgrounds:

Require very low background environment to see rare events

- Go deep underground to escape cosmic rays.
- Provide local shielding
- Use materials with ultra-low levels of radioactivity
- **Develop particle discrimination techniques....**

- Neutrons
- Electrons/gammas
- Alpha
- Neutrinos
- Non-particle induced

SNOLAB, CANADA

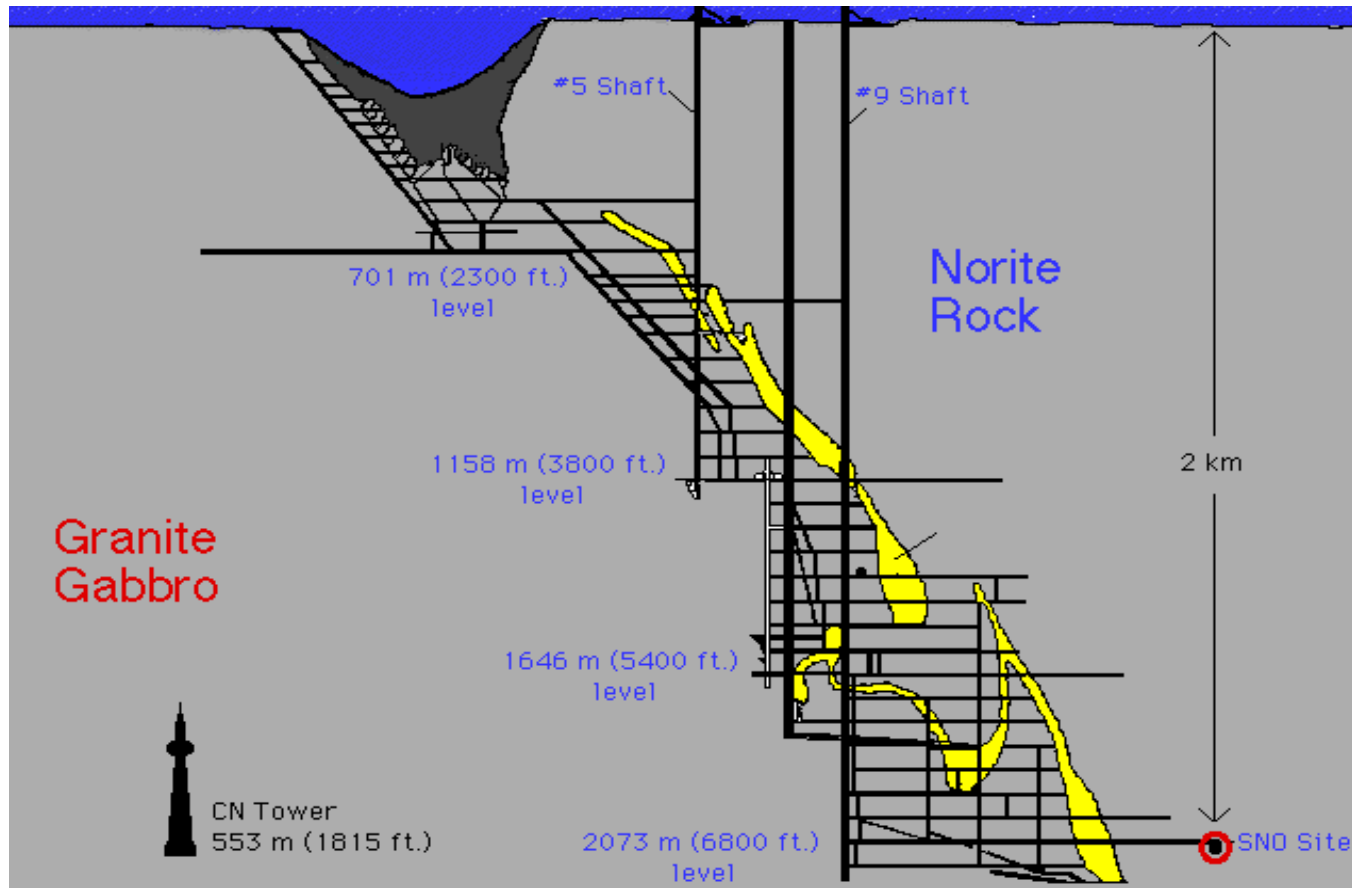

Gamma/Beta Background Rejection.

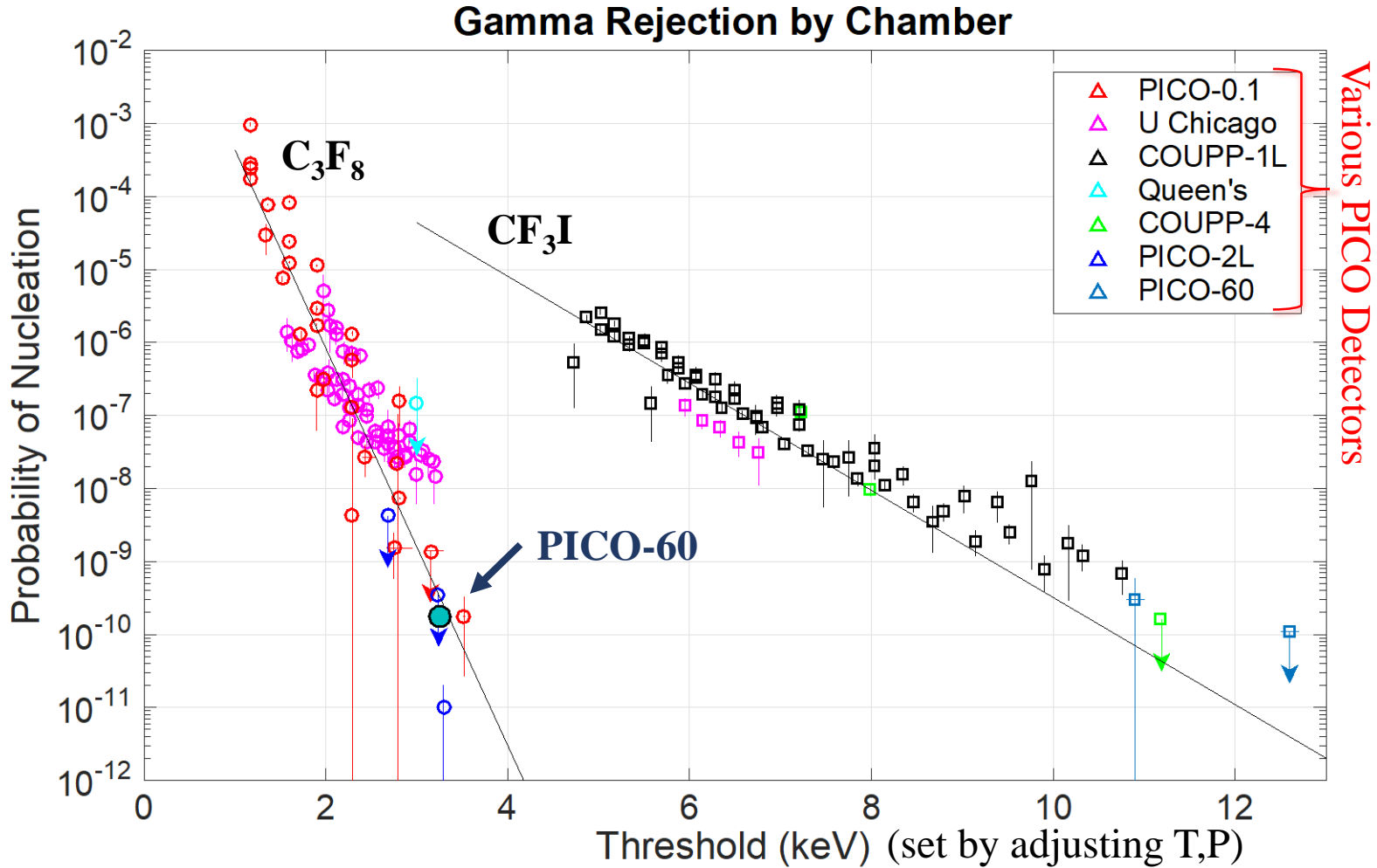

- Excellent electron/gamma rejection has been demonstrated. $< 10^{-10}$
- C_3F_8 can reach lower thresholds than CF_3I for same rejection.
- A lower threshold extends the sensitivity to lower mass WIMPs.

Alpha Acoustic Discrimination

- Discovery by PICASSO of acoustic discrimination against alphas
 - **Nuclear recoils** deposit their energy over tens of nanometers.
 - **Alphas** deposit their energy over tens of microns.
- In bubble chambers alphas are several times louder due to the difference in the rate of expansion and the number of protobubbles.

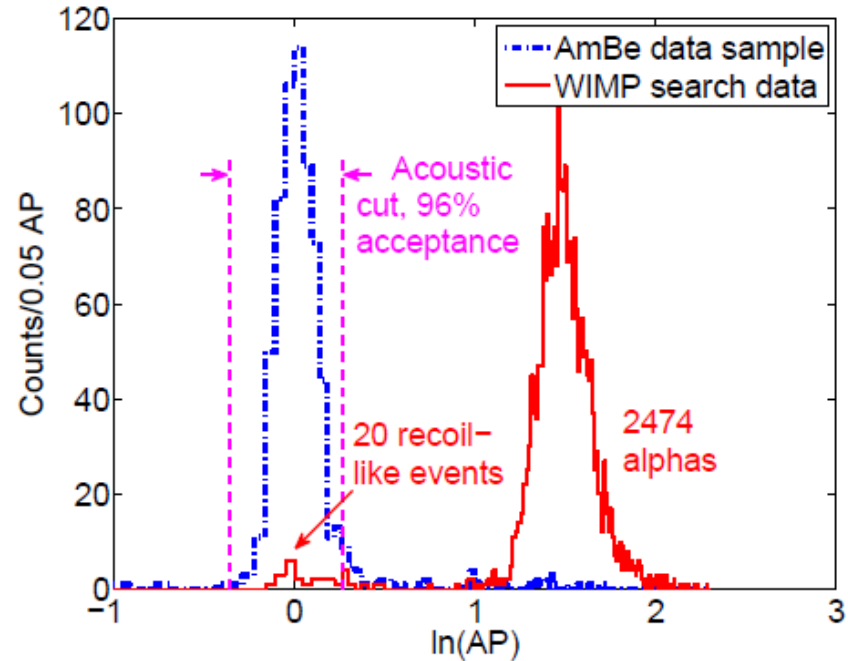

Observable bubble \sim mm

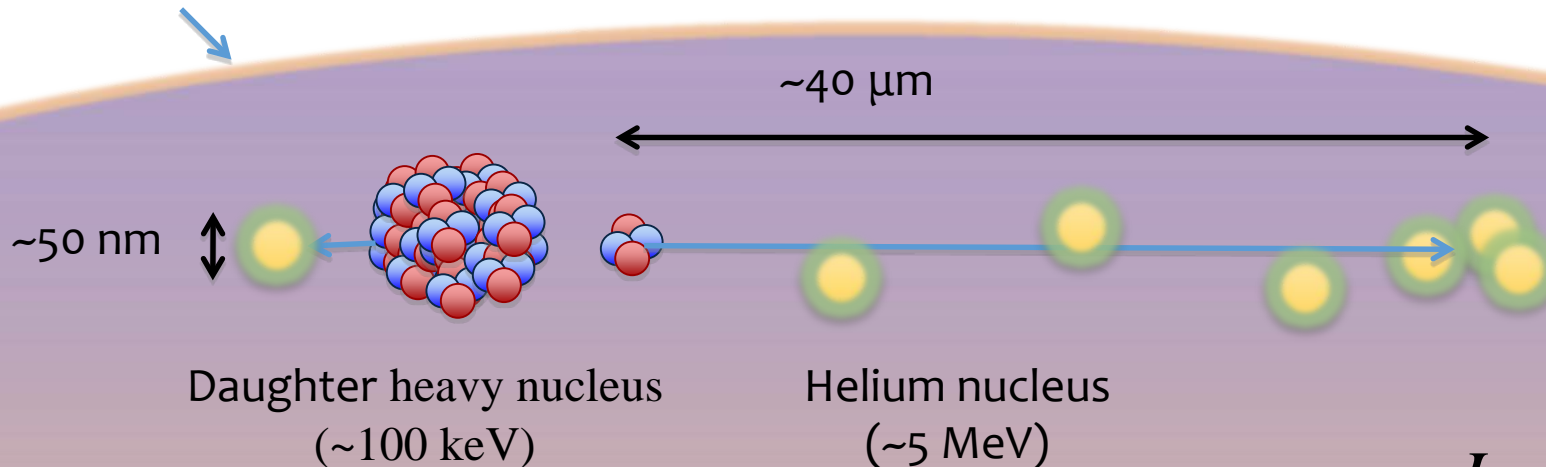

$$I = \frac{\rho \ddot{V}^2}{4\pi c}$$

Neutron Backgrounds

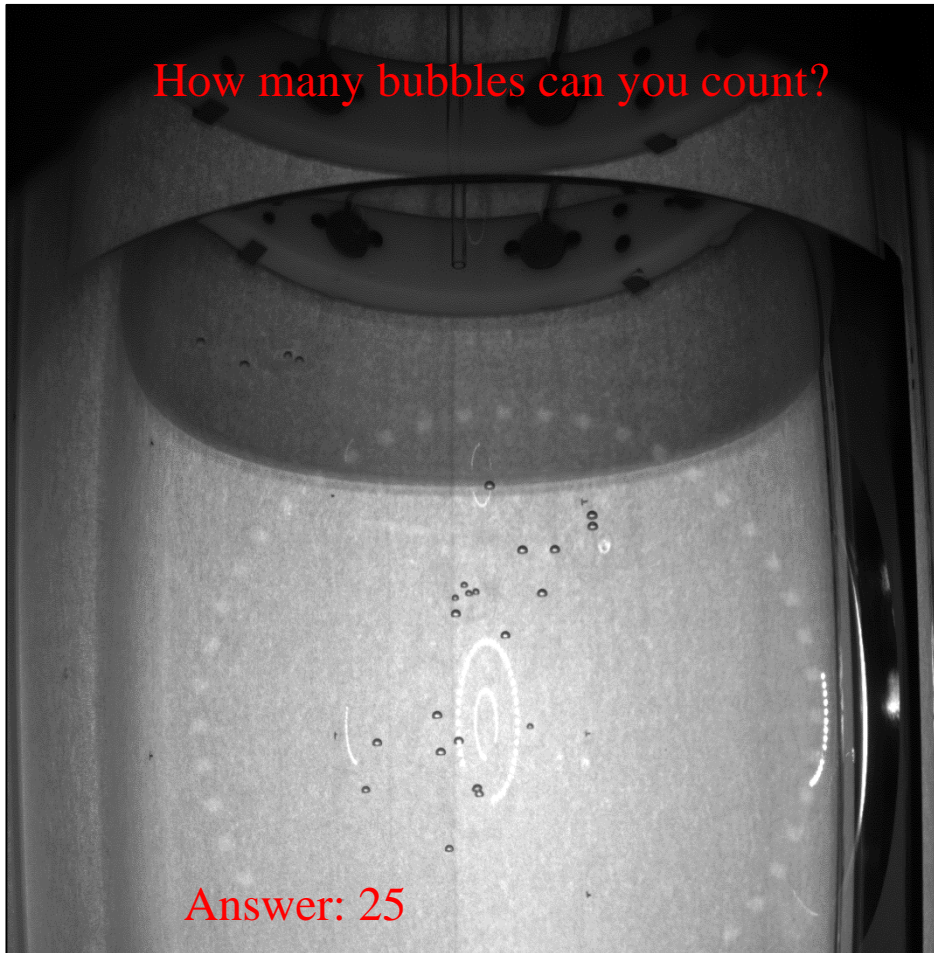

- Preferentially multiple-scatter
 - Allows us to measure background rate directly
- Simulation tells us to expect 3:1 multiples to singles ratio in PICO 60
- With water tank to shield external sources, residual background dominated by detector materials

Anomalous Background

- PICO-2L Run1
 - 9 candidate events in 32 live-days at 3.2keV
 - **Inconsistent with known radioactive backgrounds AND dark matter**
- PICO-2L Run2
 - 1 candidate event in 66 live-days at 3.2keV
 - **Consistent with neutron expectations**
- Between runs, the detector was cleaned of particulate contamination

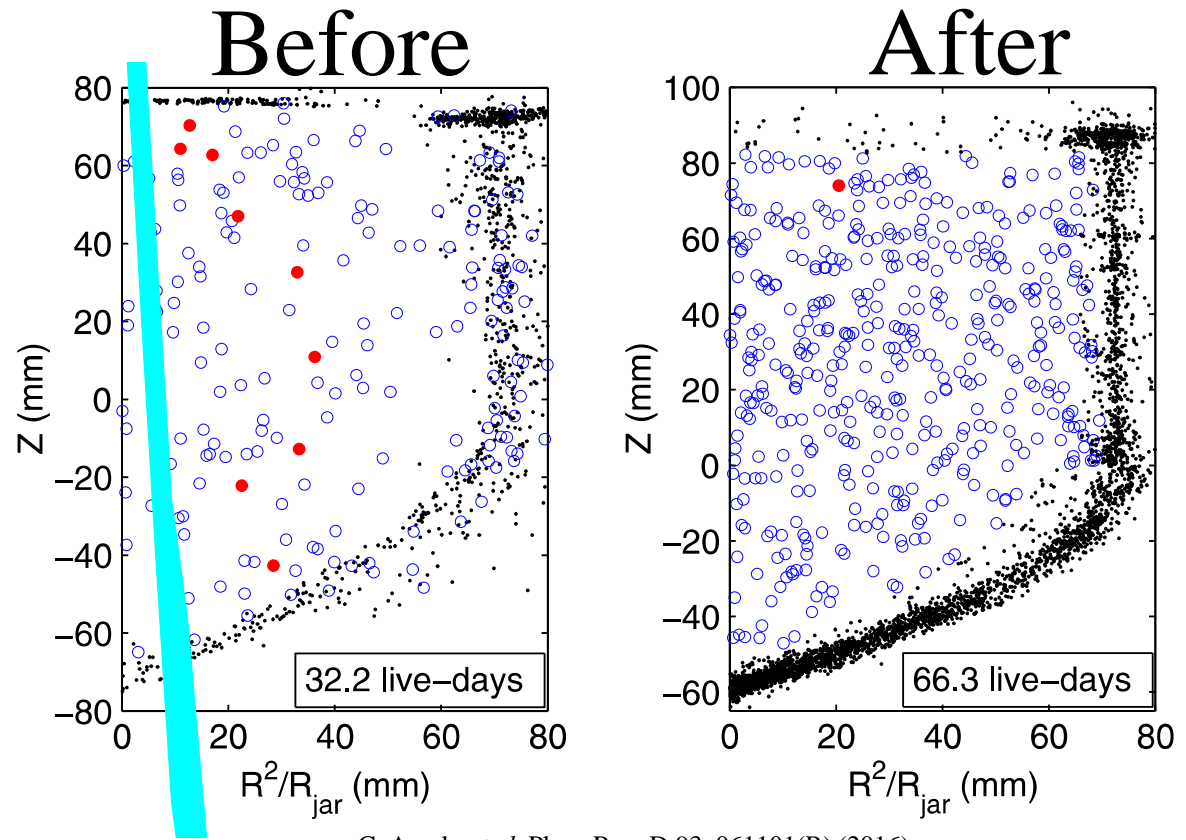

C. Amole *et al.* Phys. Rev. D 93, 061101(R) (2016)

Hypothesis: combination of particulate matter and water leads to anomalous nucleation mechanism

Latest PICO Results

- PICO is a merger of the original PICASSO and COUPP experiments (2014)
- Since then we have been progressing with a series of world leading results in SD interactions as we resolve background issues and build larger detectors:
- Brief History:
 - COUPP – 4 CF_3I (2011) Unknown background limits physics reach
 - PICO – 2L - 1 C_3F_8 (2014) Change fluid to type used by PICASSO
 - PICO – 60 - 1 CF_3I (2014) Large scale to understand background

Understand backgrounds to be related to particulates at the 10's of nm scale

- PICO – 2L – 2 C_3F_8 (2016) Background event (1) consistent with environmental neutrons

Go big !

- PICO – 60 - 2 C_3F_8 (2017) Background free. Blinded data.

Fix residual background issues and go even bigger

PICO-60 Cleaning

Every component touching the inner volume was cleaned against to the standard: MIL-STD-1246C level 50

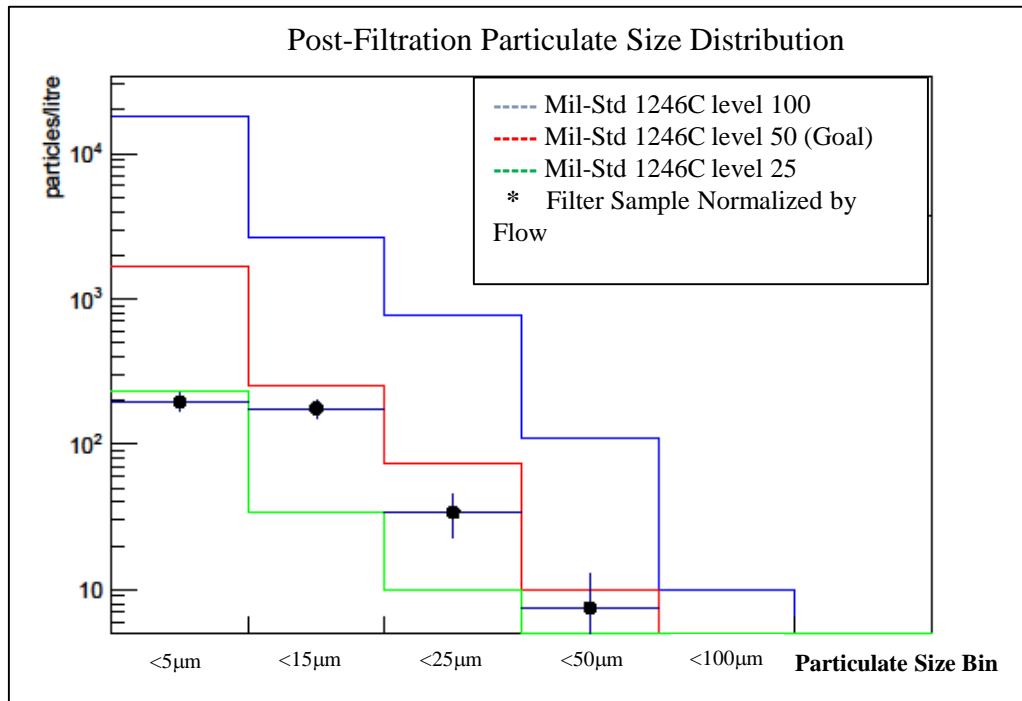

COUPP-60



Commissioning

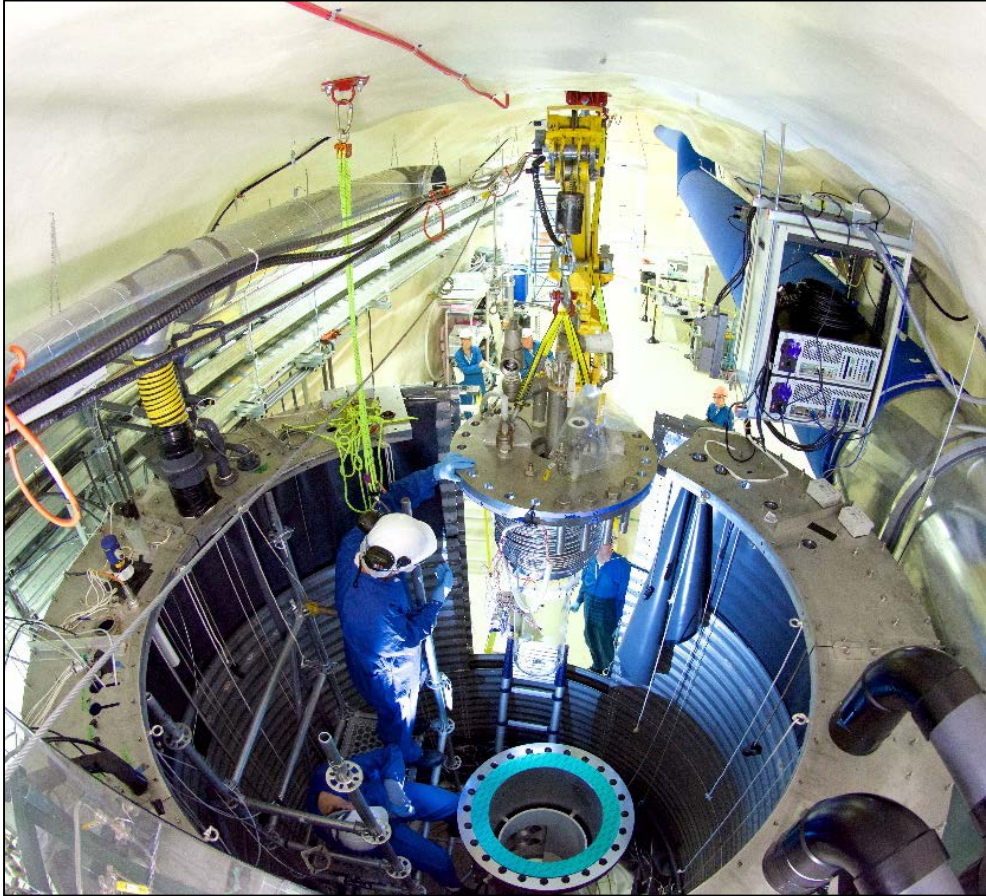

- Filled with 40L C_3F_8 on June 30, 2016
- First physics run Nov. 2016 – Jan. 2017

What do we measure?

- Camera images (primary trigger)
 - How many bubbles were there?
 - What was the bubble's position?
- Temperature
- Pressure (secondary trigger)
- Acoustic signal

Neutron Rejection

Surface Rejection

**Threshold
Determination**

Alpha Rejection

What do we measure?

- Camera images (primary trigger)
 - How many bubbles were there?
 - What was the bubble's position?
- Temperature
- Pressure (secondary trigger)

Neutron Rejection

Surface Rejection

**Threshold
Determination**

• Acoustic signal

Alpha Rejection

Blind this information

Before Opening the Box

- 106 bulk singles in WIMP search dataset
 - *Acoustics Still Blind*
 - Consistent with Rn decay rate in pre-WIMP search unblinded data
- Neutron Background
 - Not blinded to multiplicity
 - 3 multiple bubble events in the physics data
 - Multiples to singles ratio is approximately 3:1 from calibration and simulation
- **Conclusion: 0-3 bulk singles would be consistent with neutrons and no anomalous background**

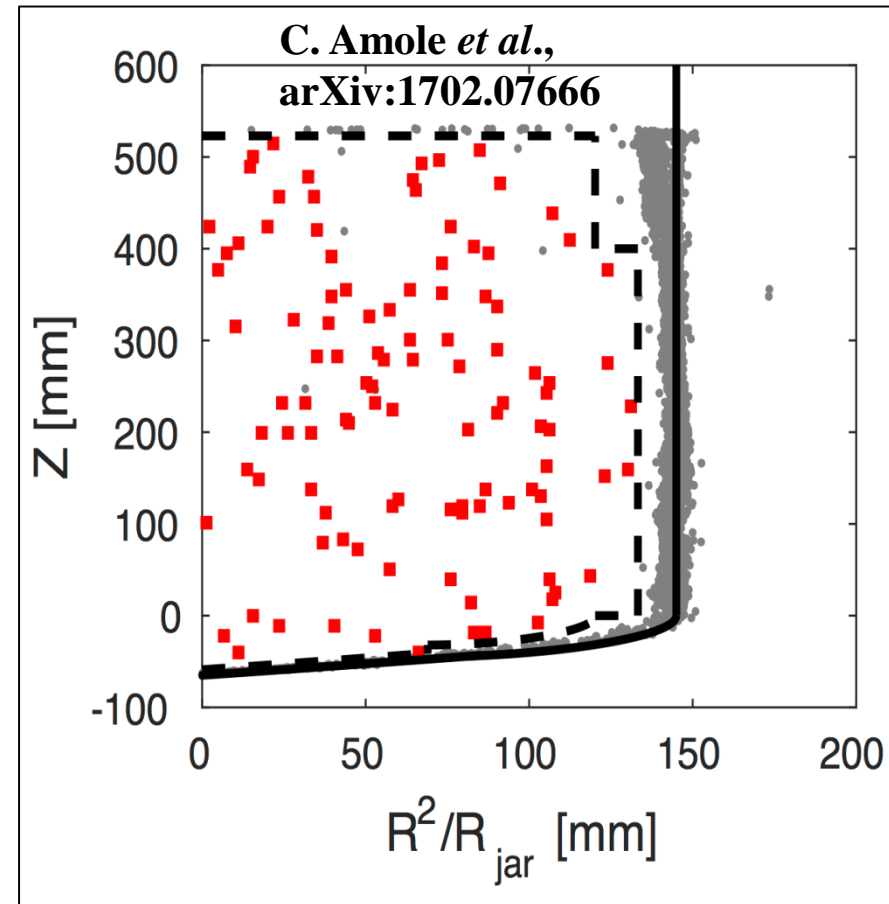

After Opening the Box

C. Amole *et al.*,
arXiv:1702.07666

No events in
signal
region!

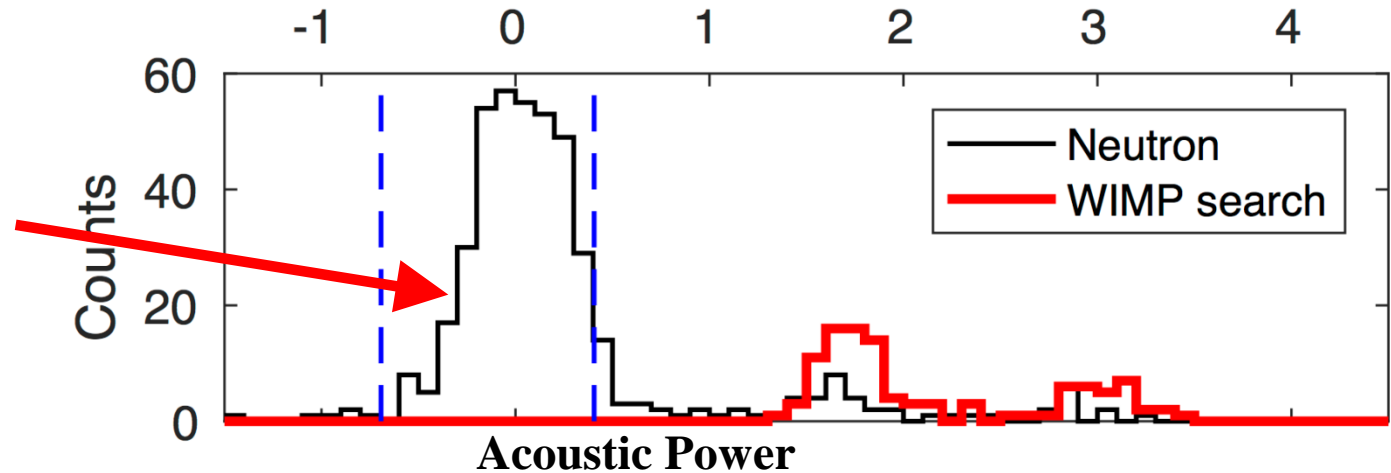

- Of the 106 fiducial-bulk singles, **none** are consistent with nuclear recoil hypothesis (all are consistent with radon chain alphas)
- No background events observed !
- Blind analysis

Spin-Dependent WIMP-Proton Coupling

Recent (2017) Limits from PICO-60

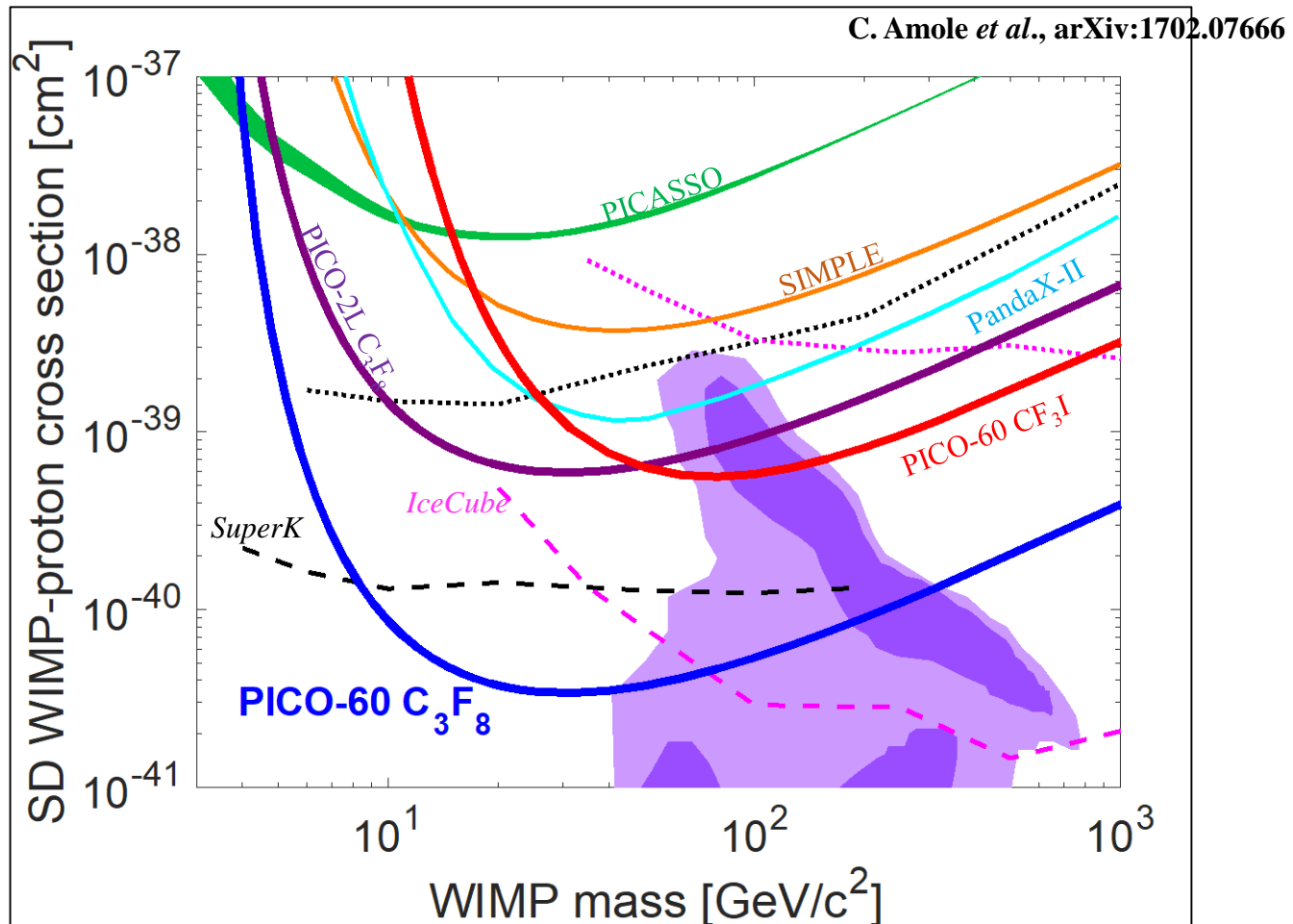

- PICO-60 – Blind analysis, 0 events observed, x17 improvement to set world best limit on spin dependent proton coupling

Future Plans:

- PICO 40 ~ now
- PICO 500 ~ 2019

PICO-40L: Eliminate buffer fluid

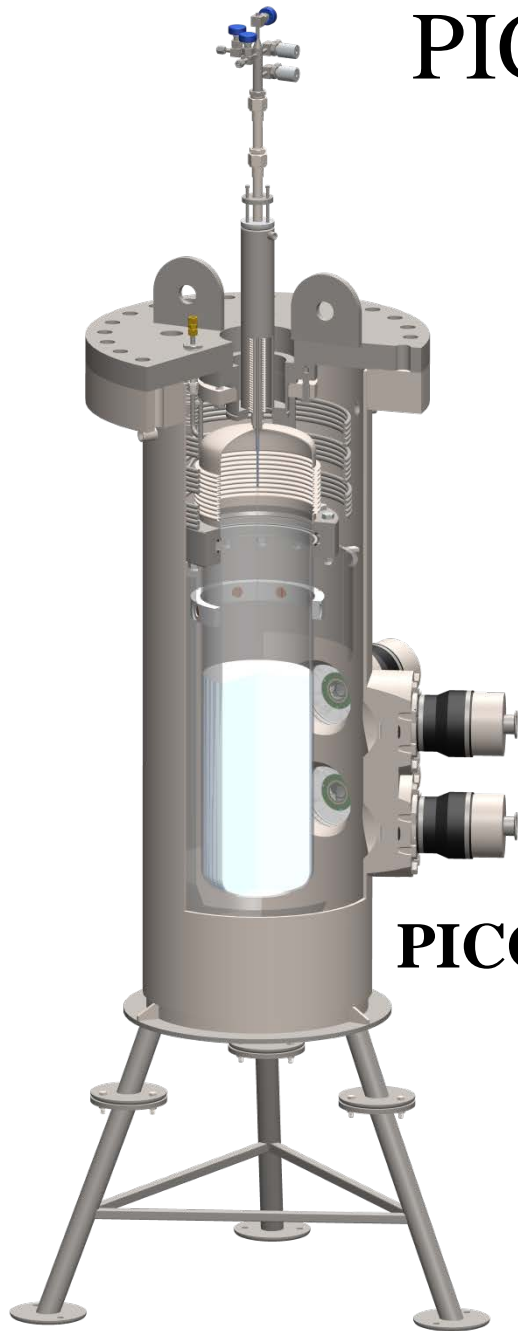

PICO-60

Purpose of buffer liquid is to isolate the active liquid from the stainless parts

PICO-40L

Thermal gradient can ensure that target fluid near stainless parts is not active

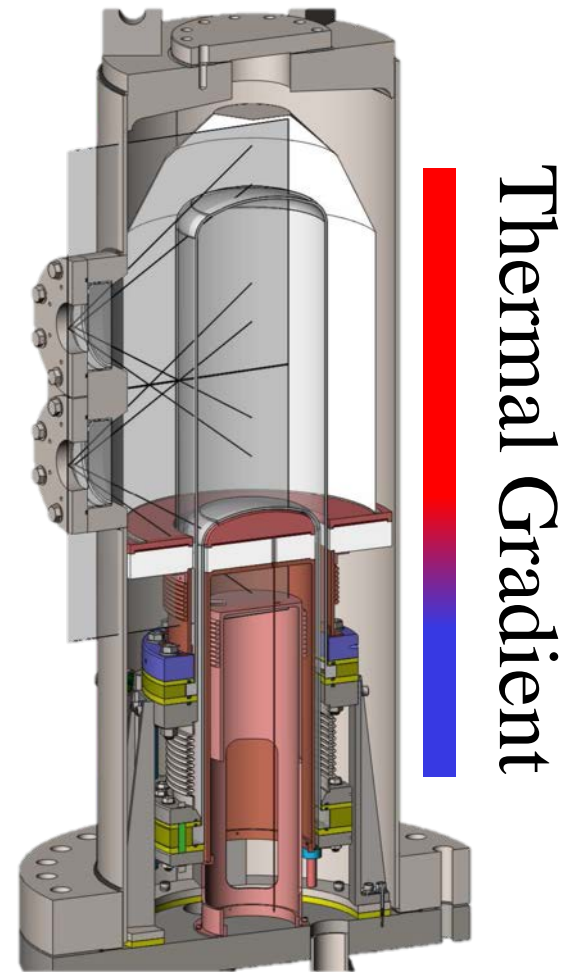

Thermal Gradient

PICO-40L

Main Objectives

- Reduced neutron backgrounds, allowing us to push down in cross-section. We expect an order of magnitude improvement in exclusion by running for a year.
- Added stability could allow us to push down in threshold (WIMP mass) until we hit electron-recoil backgrounds.
- Ability to use new target fluids optimized for different WIMP masses
- Tests technology for future tonne scale detector: PICO 500

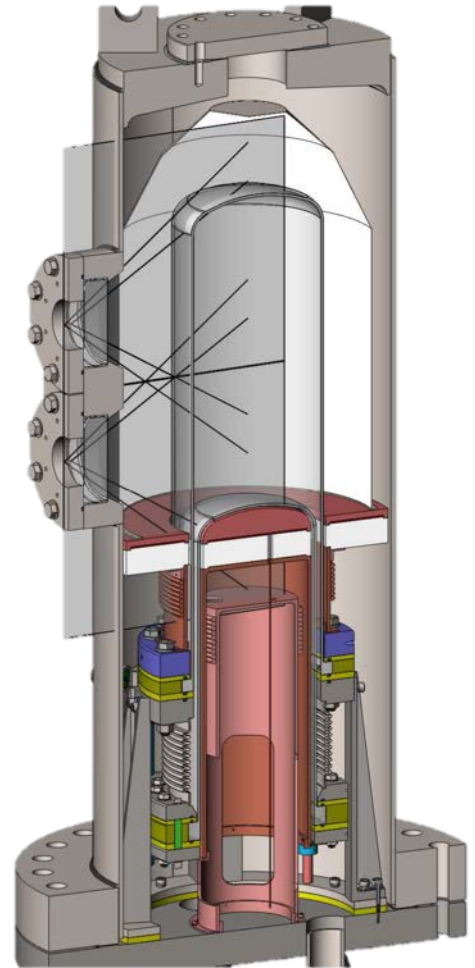

Advantages

Elimination (~entirely) of anomalous backgrounds

- Backgrounds caused by
 - Water,
 - Particulates,
 - Surface tension effects
- Elimination of Water will break the chain

Additional technical benefits of no water buffer:

- Can operate below $^{\circ}\text{C}$
- Active fluid choice does not require a compatible buffer fluid
- Full recirculation & in-place purification is technically possible

40-liter
Superheated
Volume
 15°C

Cold Normal
Liquid
 -25°C

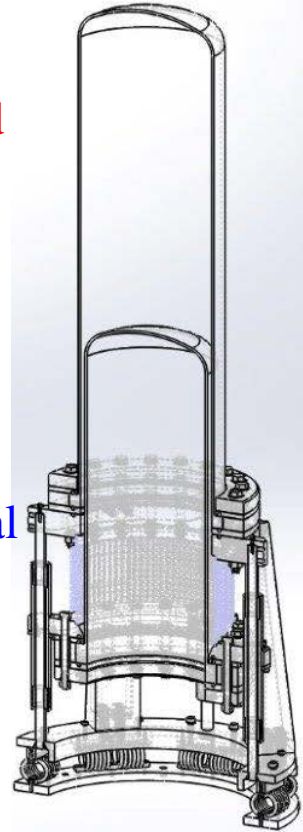

36-inch Diameter Pressure Vessel (much larger than before to keep neutrons at bay).



New Larger Capacity Hydraulic System
(Necessary for larger diameter pressure vessel)

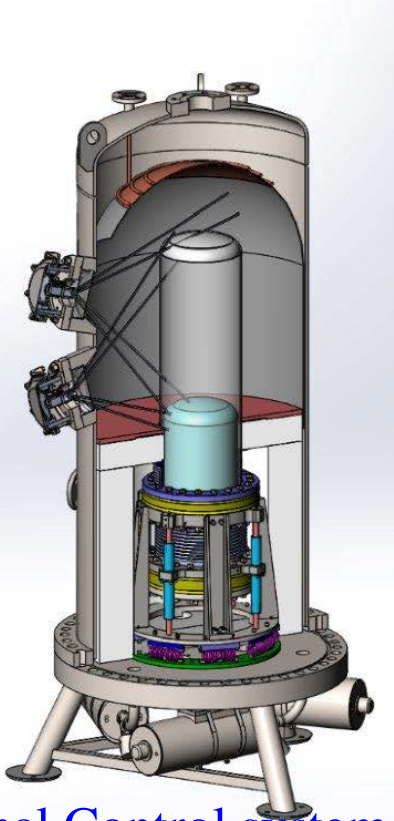
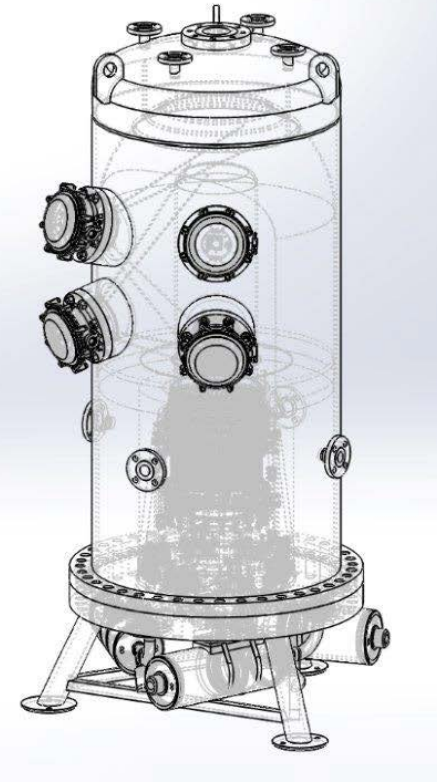

New Thermal Control system
(Necessary to maintain dual temperature zones)

Schedule:

- All significant components have been fabricated and are on site.
- Installation work is underway. Expected to be complete by August
- Commissioning to begin in the fall to establish running conditions, do calibrations, etc.

- After initial open data set to establish good working conditions, the experiment will be blinded.

- Roughly one year of exposure is planned for the moment.

- Early commissioning data will be used to finalize design of PICO 500



PICO-500

- Engineering work ongoing as part of R&D program
- Funding (~\$5M CAD) has been awarded. Going through final budget finalization with agency now. Cash flow early 2018
- Construction envisioned for 2019

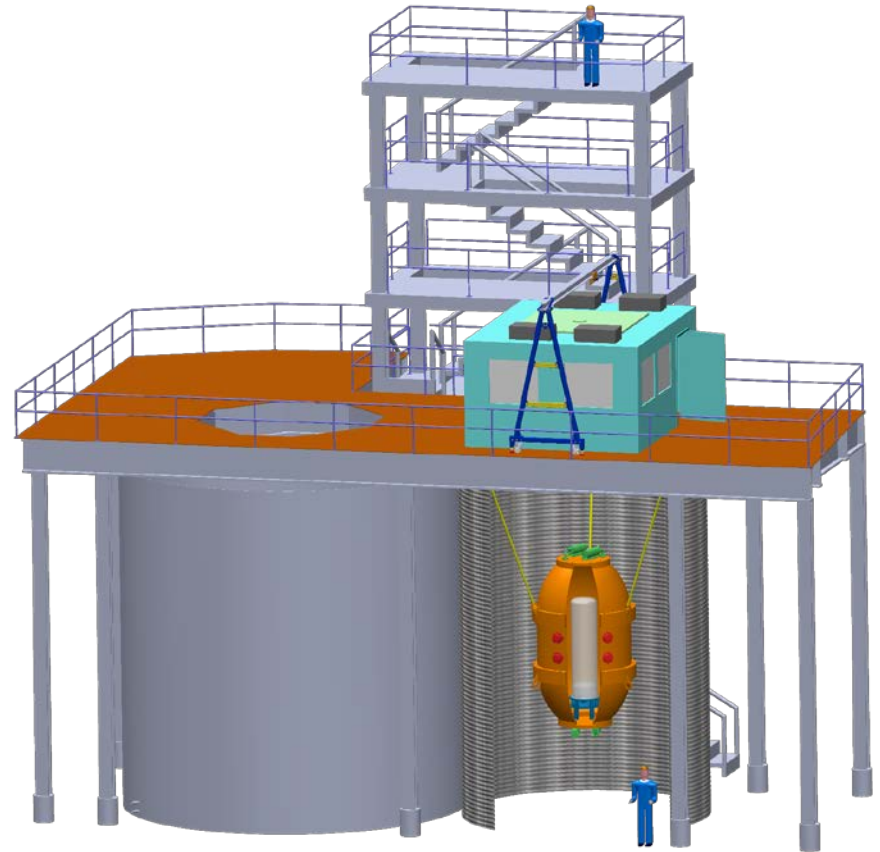
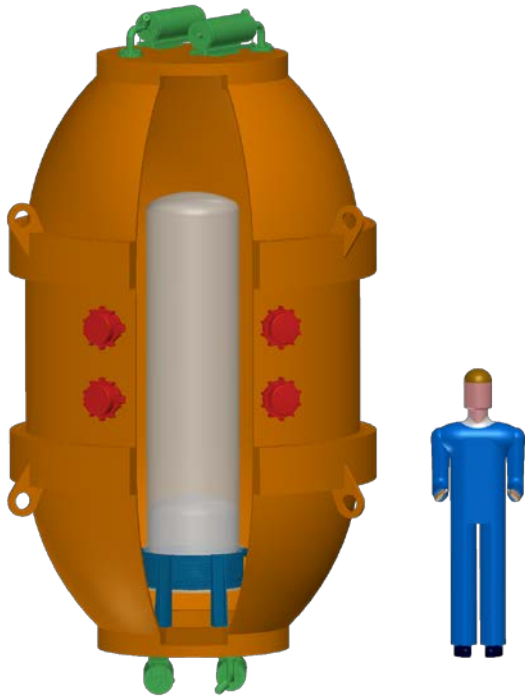

Spin-Dependent Future

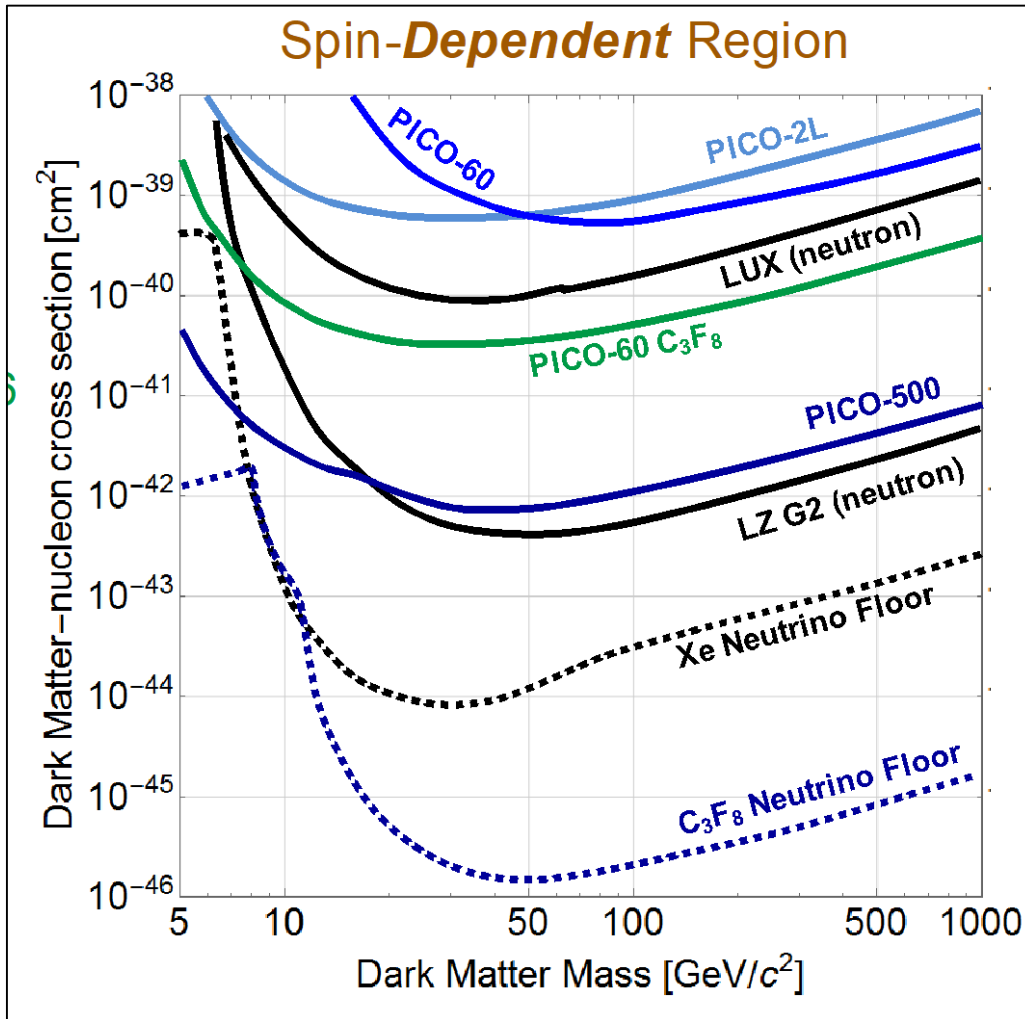

- PICO program has significant reach in parallel to G2 experiments
- Lower neutrino floor opens unique phase to PICO

Summary

- PICO bubble chambers at the 40L scale can be built background-free
- PICO dominates the search for spin-dependent WIMP-proton couplings
- Construction of PICO 40 is well underway
- The design of PICO 500 is very advanced. Final technology choice for inner vessel to be made based on PICO 40 experience.

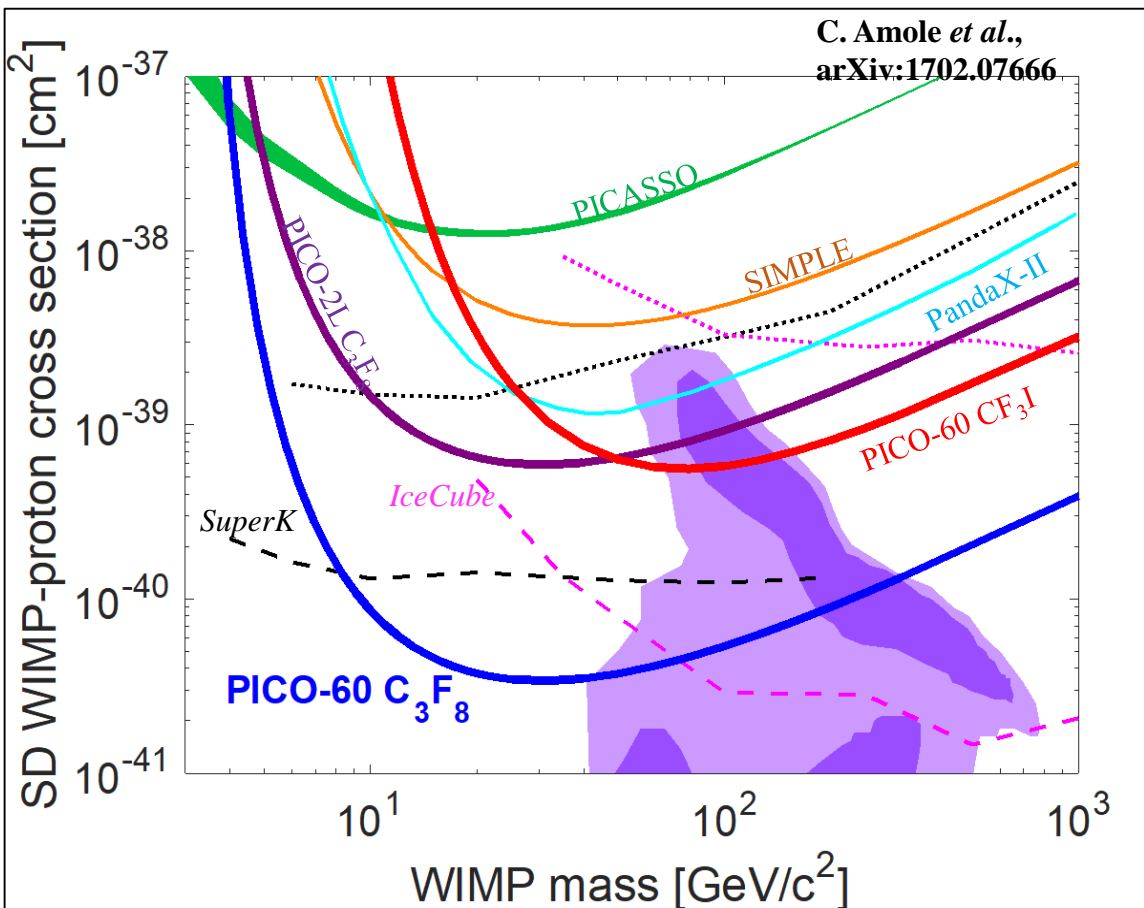

PICO



O. Harris



R. Filgas, I. Stekl



Kavli Institute
for Cosmological Physics
at The University of Chicago

J.I. Collar



S. Chen, M. Laurin,
J.-P. Martin, A. Plante,
A.E. Robinson, N. Starinski,
F. Tardif, D. Tiwari, V. Zacek,
C. Wen Chao,



I. Lawson



M. Ardid, M. Bou-Cabo, I. Felis



M. Bressler, R. Neilson



P.S. Cooper, M. Crisler,
W.H. Lippincott, A. Sonnenschein



C. Coutu, S. Fallows,
C. Krauss, M.-C. Piro



D. Baxter, C.E. Dahl, M. Jin,
J. Zhang



Pacific Northwest
NATIONAL LABORATORY

I. Arnquist, C. Cowles, C.M.
Jackson, B. Loer, K. Wierman



INDIANA UNIVERSITY
SOUTH BEND

E. Behnke, I. Levine, T. Nania



M. Das, S. Sahoo,
S. Seth



PennState

D. Maurya, S. Priya,
Y. Yan



E. Vázquez-Jáuregui



B. Broerman, G. Cao, K. Clark,
G. Giroux, C. Hardy, C. Moore,
A. Noble



J. Farine, A. Le Blanc, C. Licciardi,
O. Scallon, U. Wichoski

Spin-independent Limits

- Light nuclear targets give sensitivity to low-mass WIMPs
- Unexplored phase space would be accessible with slightly reduced threshold

