

Physics at high energies (PHE) report

Stefania Gori

University of Cincinnati

Verena Martinez Outschoorn

UMass Amherst

CIPANP-2018

13th conference on the intersections of particle and nuclear physics

Palm Springs

June 3, 2018

Physics at High Energies

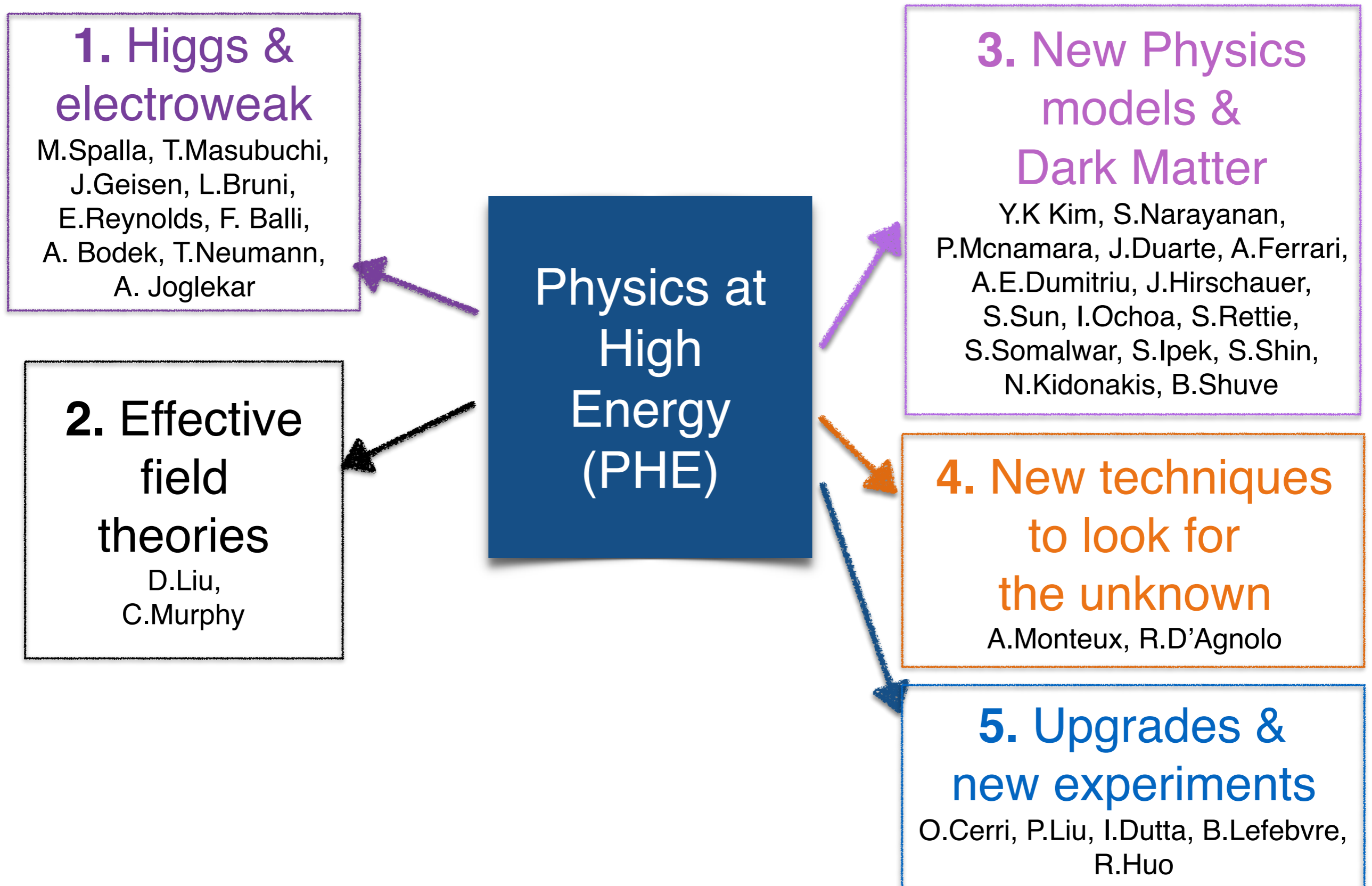

Experimental Talks

1. Higgs & electroweak

M.Spalla, T.Masubuchi,
J.Geisen, L.Bruni,
E.Reynolds, F. Balli,
A. Bodek

Physics at High Energy (PHE)

3. New Physics models & Dark Matter

Y.K Kim, S.Narayanan,
P.Mcnamara, J.Duarte, A.Ferrari,
A.E.Dumitriu, J.Hirschauer,
S.Sun, I.Ochoa, S.Rettie,
S.Somalwar

5. Upgrades & new experiments

O.Cerri, P.Liu, I.Dutta, B.Lefebvre

Disclaimer: many results shown this week, impossible to adequately summarize everything. Choices influenced by new results, open questions, etc
Apologies if we missed your favorite result!

Higgs Results

Major progress in the 6 years since the Higgs discovery

Firmly established $\gamma\gamma$, ZZ , $\tau\tau$, WW decays

$$H \rightarrow \gamma\gamma$$

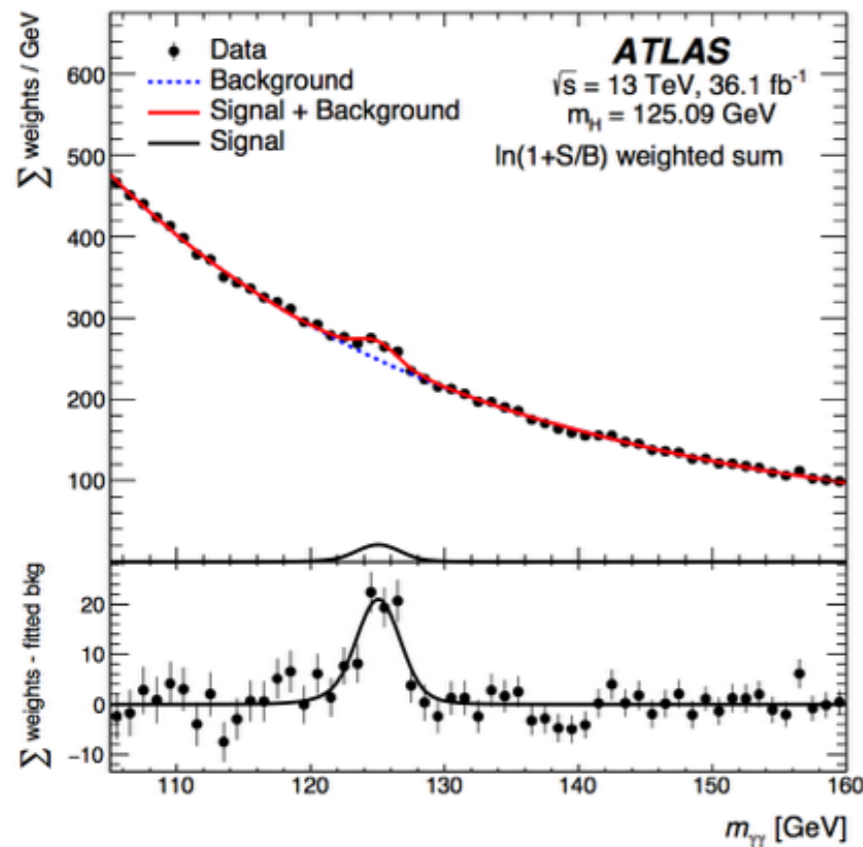

$$H \rightarrow ZZ^*$$

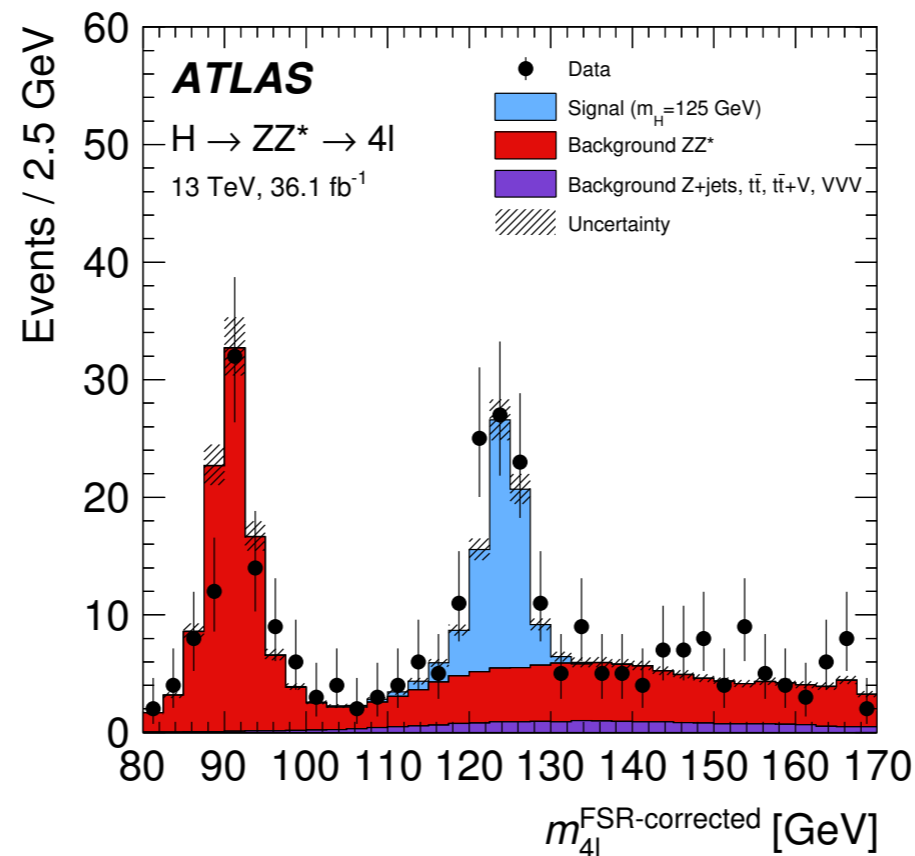

$$H \rightarrow WW^*$$

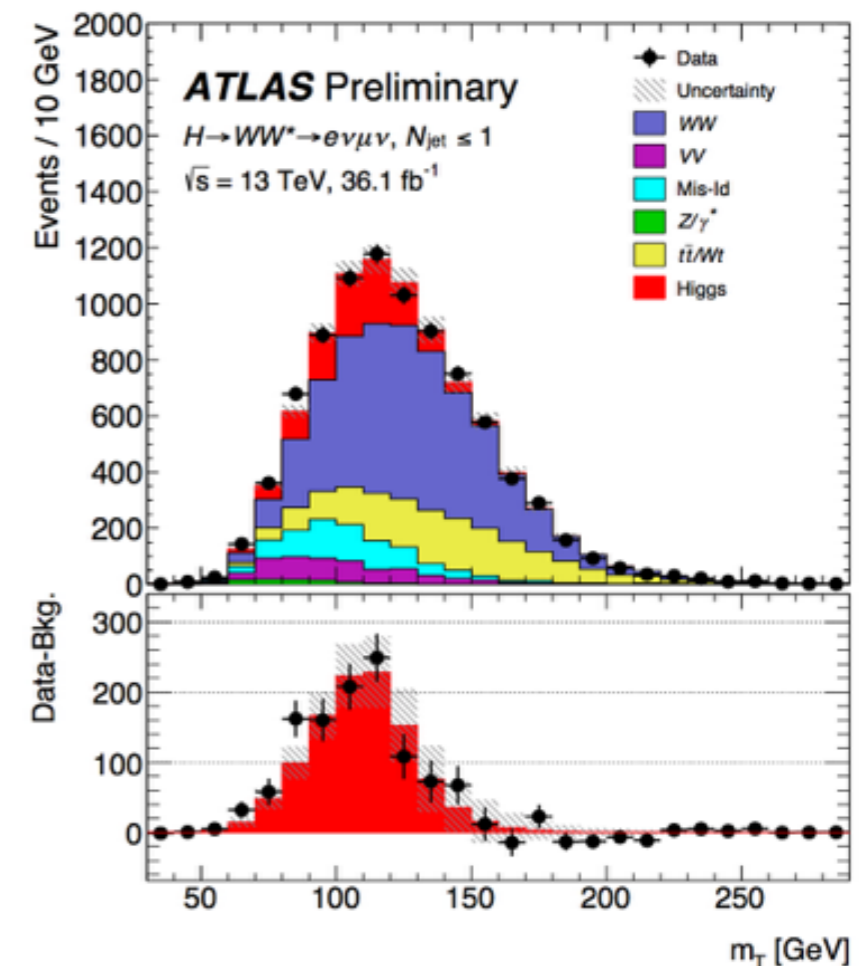

Higgs Precision Measurements

Major progress in the 6 years since the Higgs discovery

Firmly established $\gamma\gamma$, ZZ , $\tau\tau$, WW decays

Higgs Physics has entered the precision era

$H \rightarrow \gamma\gamma$ and $H \rightarrow ZZ^*$

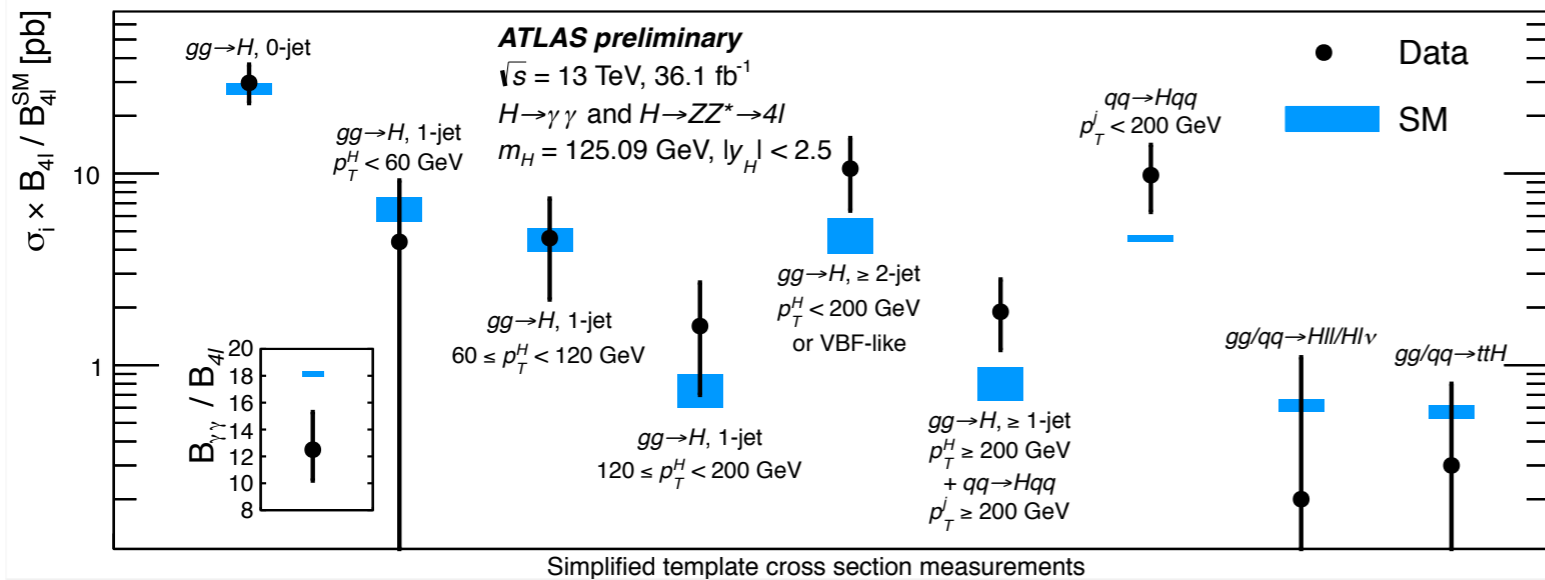

see talk by
L. Bruni (parallel)

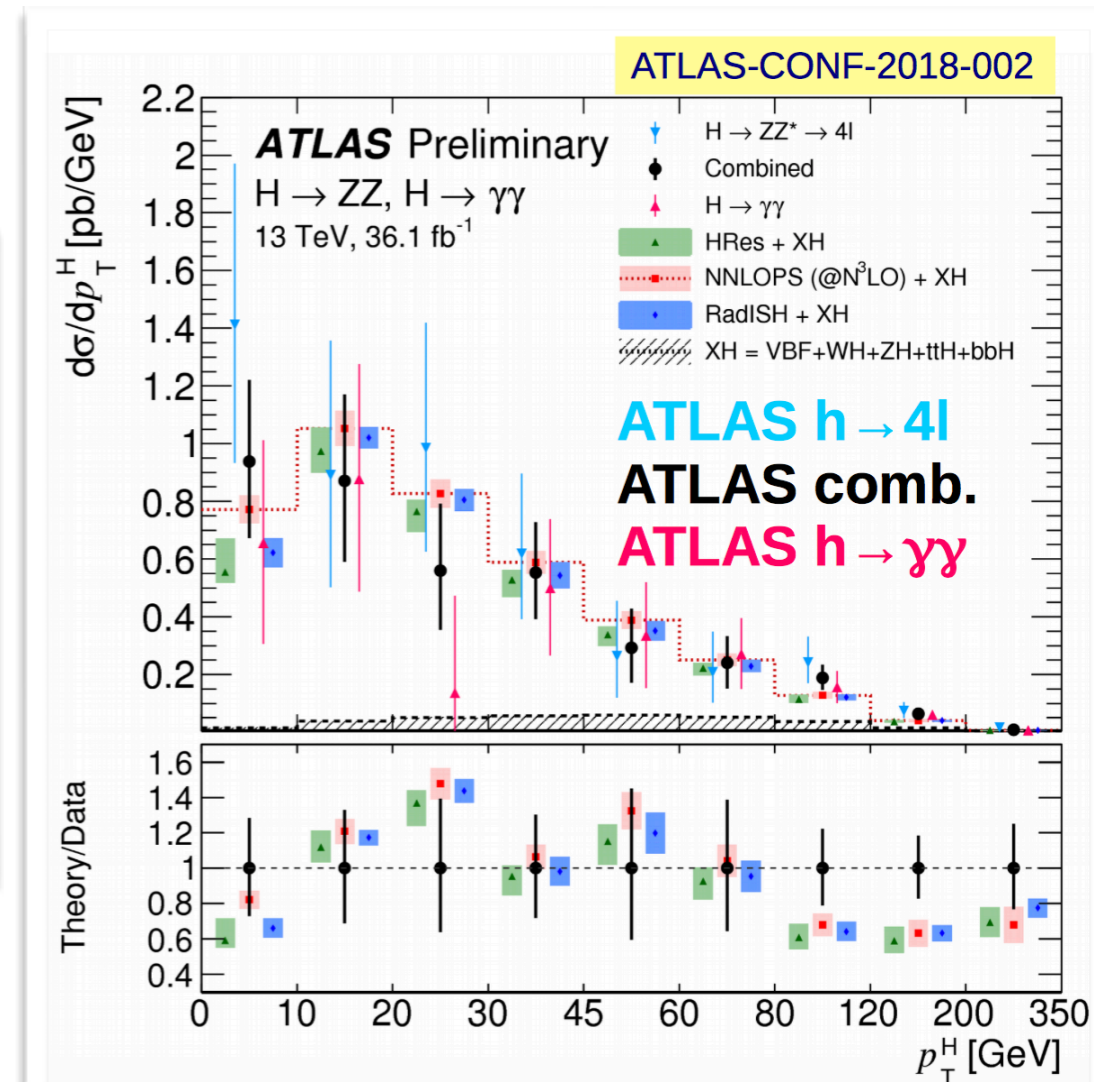

Coupling to heavy quarks: Observations

see talk by T. Masubuchi (parallel)

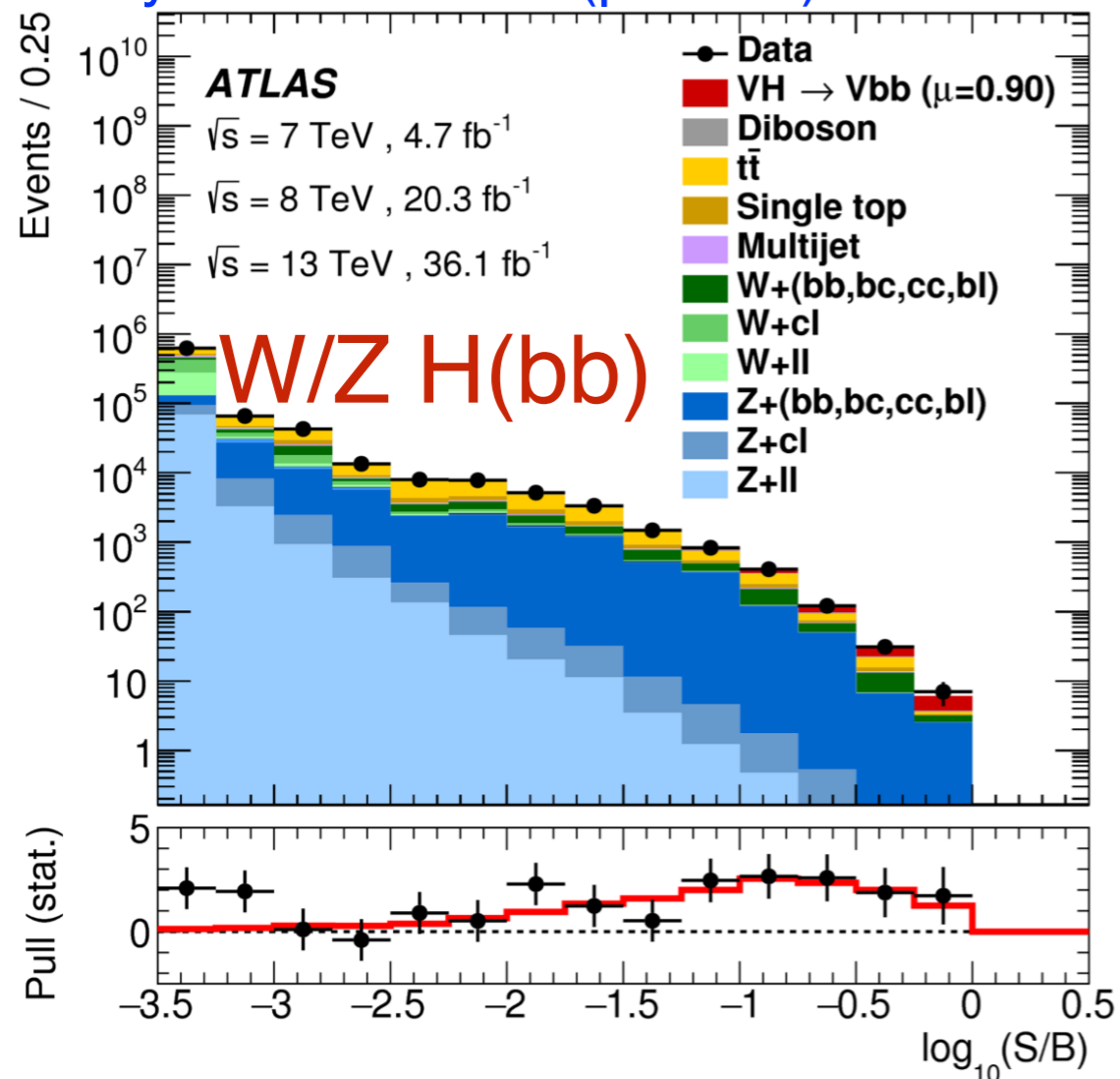

see talk by J. Geisen (parallel)

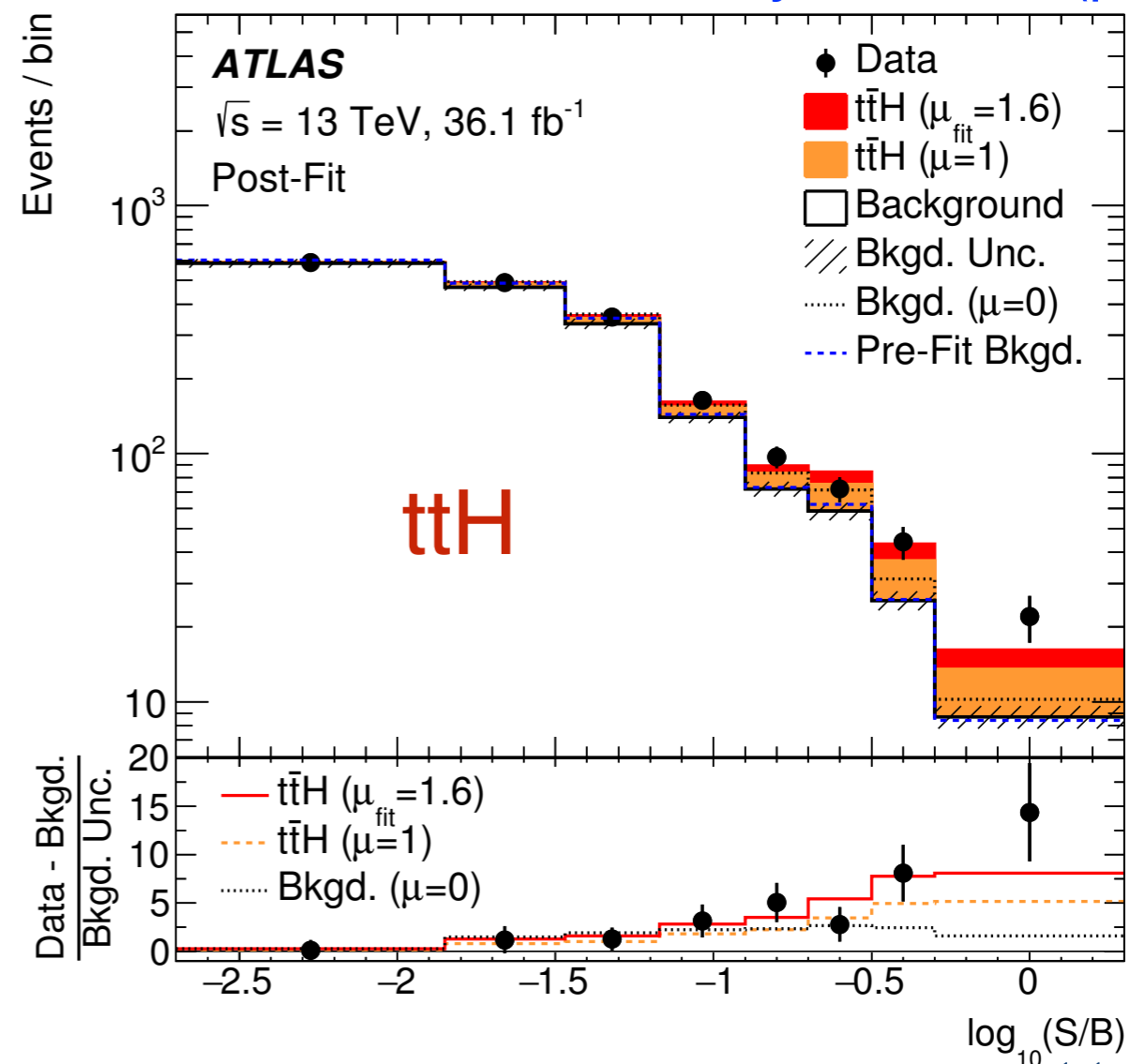

Main decay mode $B(H \rightarrow bb) = 0.58$

Combined all datasets (7, 8 & 13 TeV)

ATLAS result: Observed significance
3.6 σ (expected 4.0 σ)

Largest Yukawa coupling

All channels with 36.2 fb⁻¹ at 13 TeV

ATLAS result: Observed significance
4.2 σ (expected 3.8 σ)

Higgs Boson Pairs

$hh \rightarrow \gamma\gamma bb$

New!

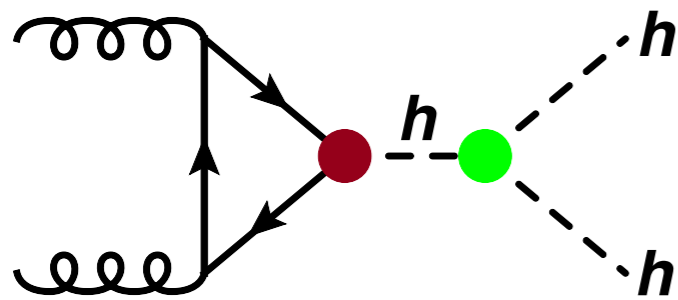

Higgs self-coupling is check of electroweak symmetry breaking

$$\sigma(pp \rightarrow hh) = 33 \text{ fb at } 13 \text{ TeV}$$

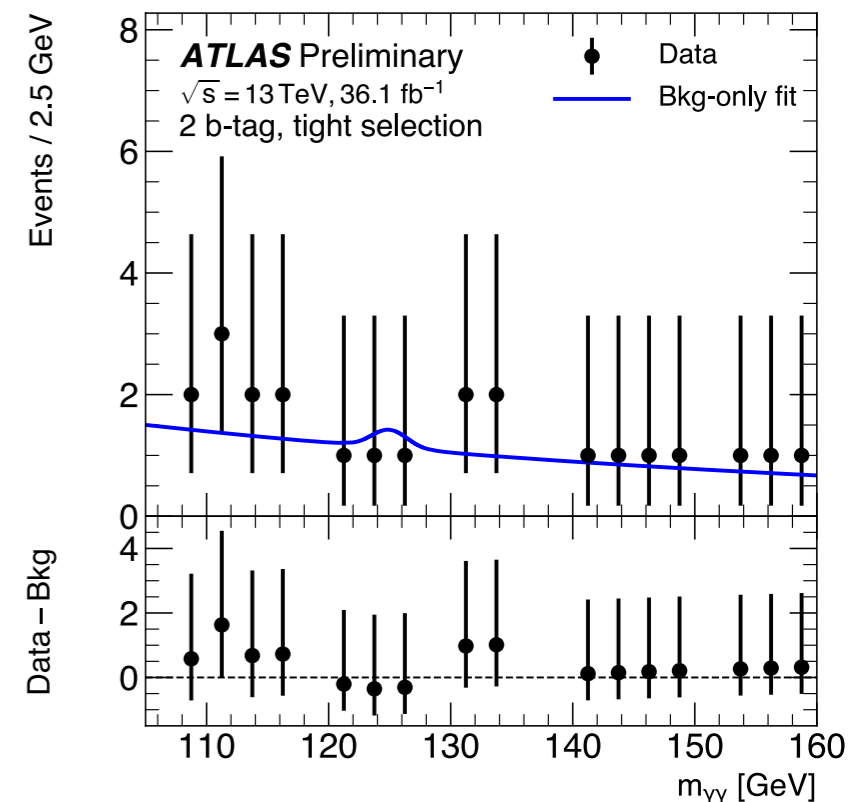
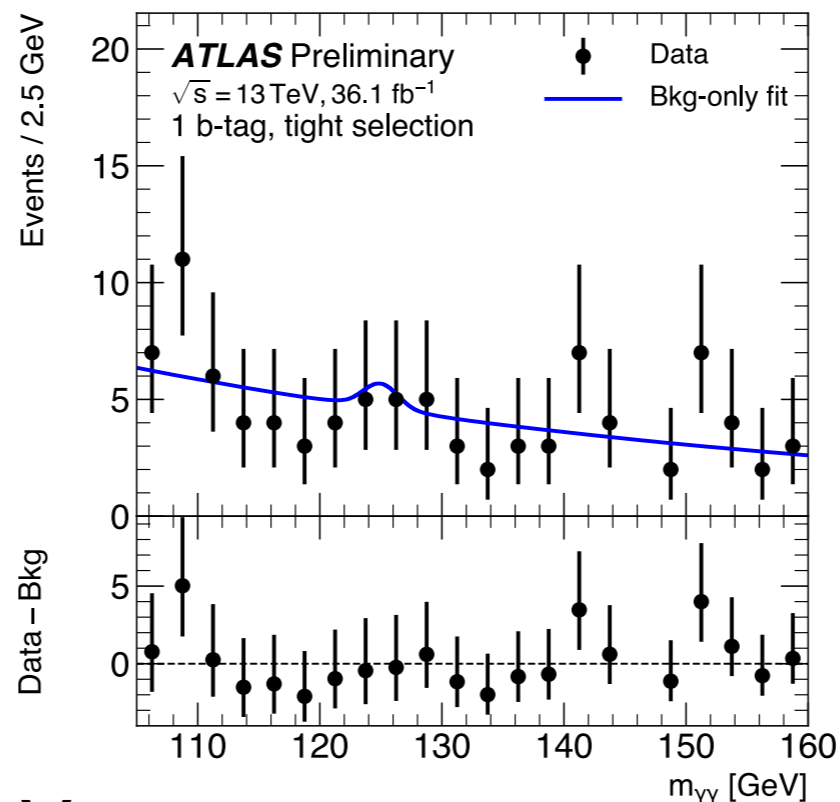

$hh \rightarrow \gamma\gamma bb$ with 36.2 fb^{-1} at 13 TeV

ATLAS result: Observed significance $22 \times \sigma_{SM}$ (expected $28 \times \sigma_{SM}$)

Most sensitive result: $hh \rightarrow bbbb$ with 36.2 fb^{-1} at 13 TeV

ATLAS result: Observed significance $13 \times \sigma_{SM}$ (expected $21 \times \sigma_{SM}$)

see talk by

A. Ferrari (parallel)

Precision Measurements: W Mass

see talk by
F.Balli (parallel)

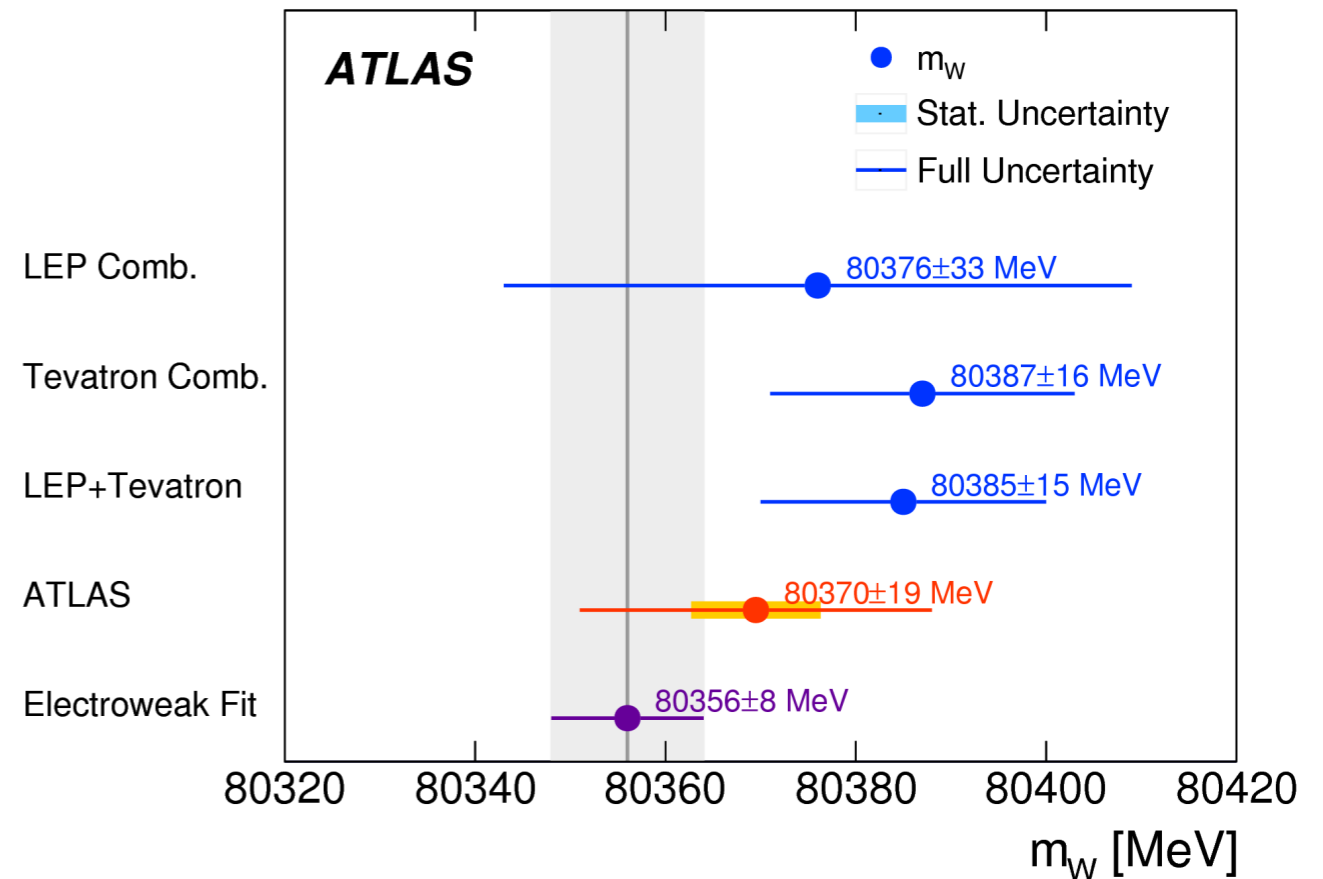
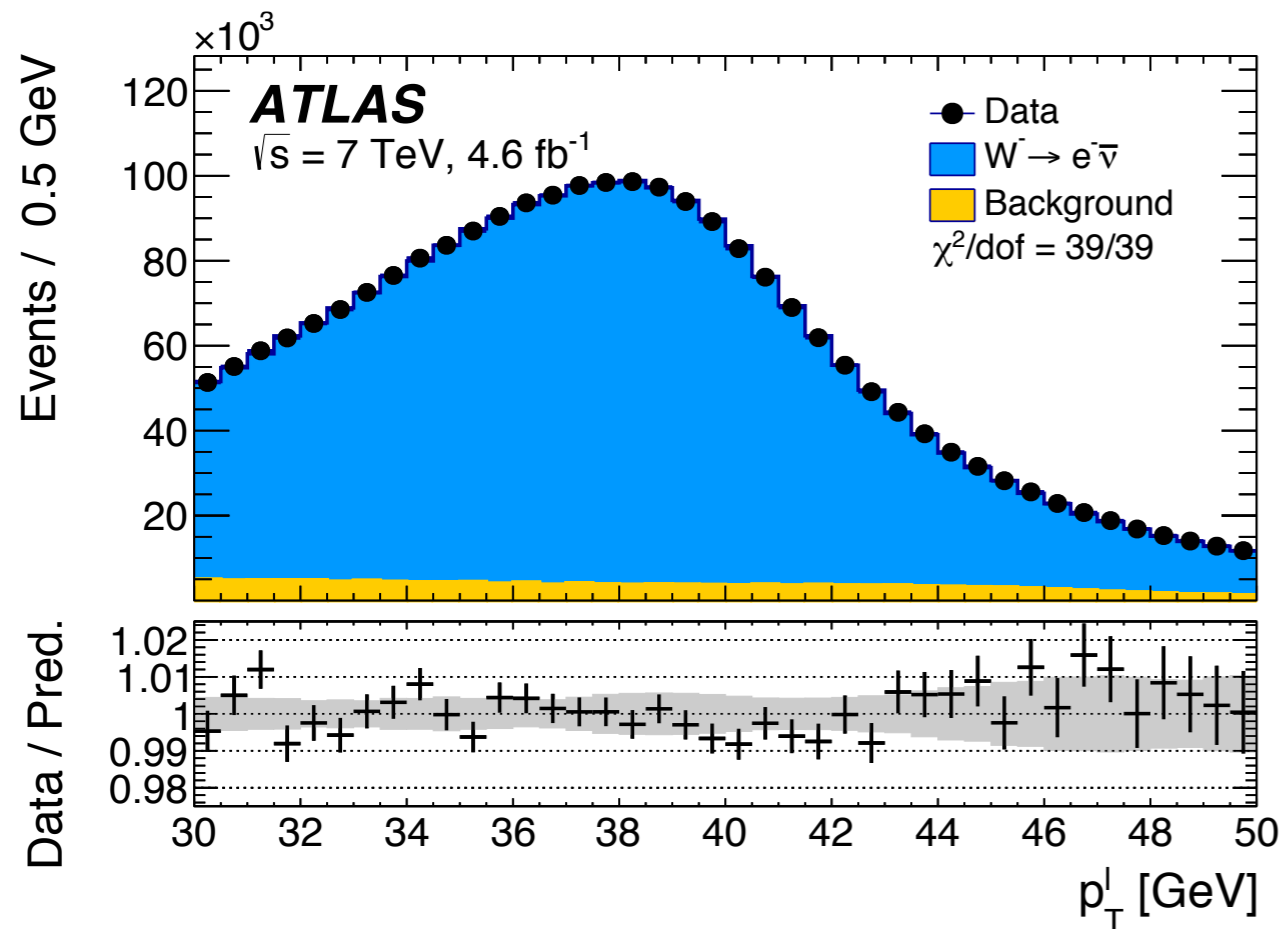

$$m_W = 80370 \pm 7 \text{ (stat)} \pm 11 \text{ (exp. syst.)} \pm 14 \text{ (mod. syst.) MeV}$$

$$= 80370 \pm 19 \text{ MeV}$$

- Other results
 - Multiboson production [see talk by M.Spalla \(parallel\)](#)
 - EW mixing angle from Z boson measurements [see talk by A.Bodek \(parallel\)](#)

Exotic Higgs Searches

Higgs is possible gateway to physics beyond the SM

Program of searches for exotic decays of the SM Higgs, standard decays of exotic higgs and more complex combinations

$$H \rightarrow XX \rightarrow 4\ell, \quad X = a, Z_d$$

$$H \rightarrow aa \rightarrow 2\mu 2\tau$$

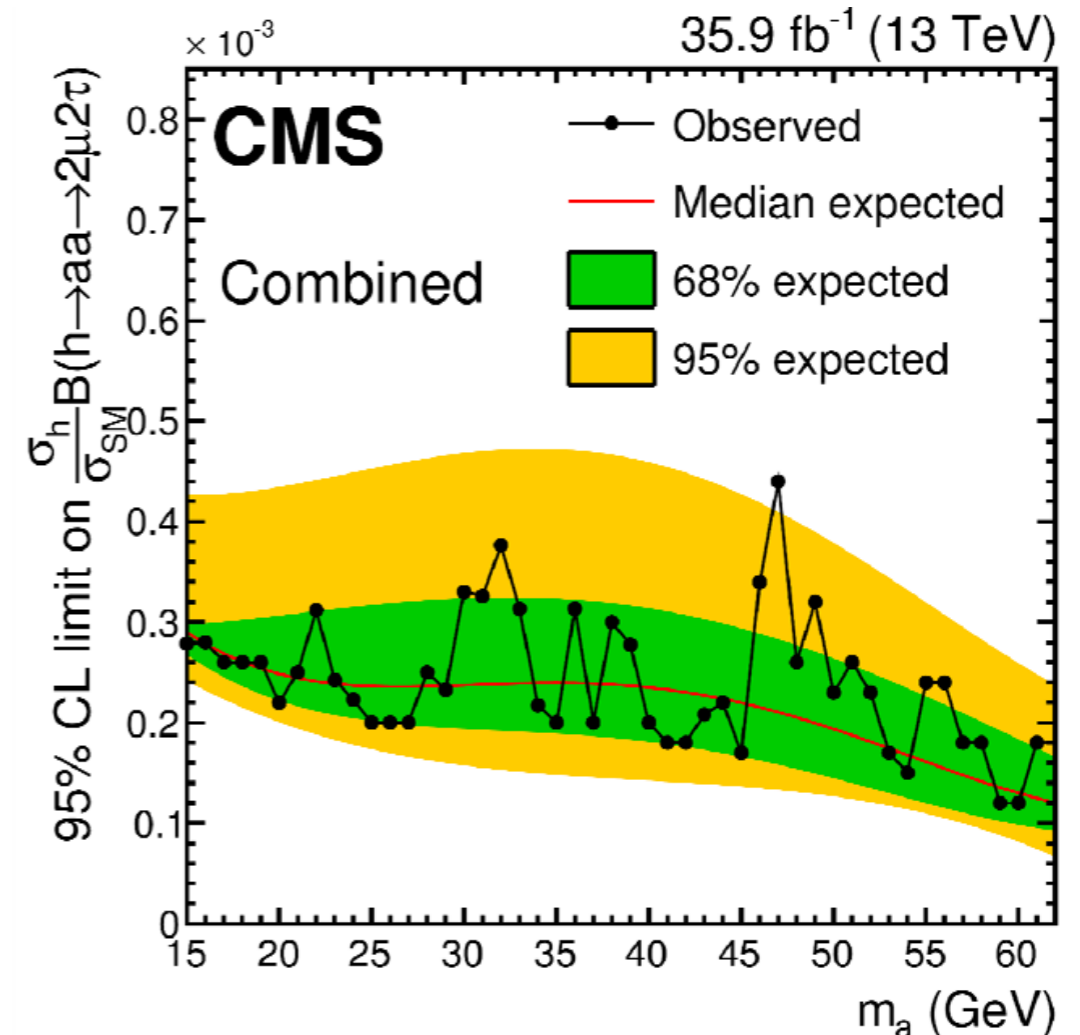
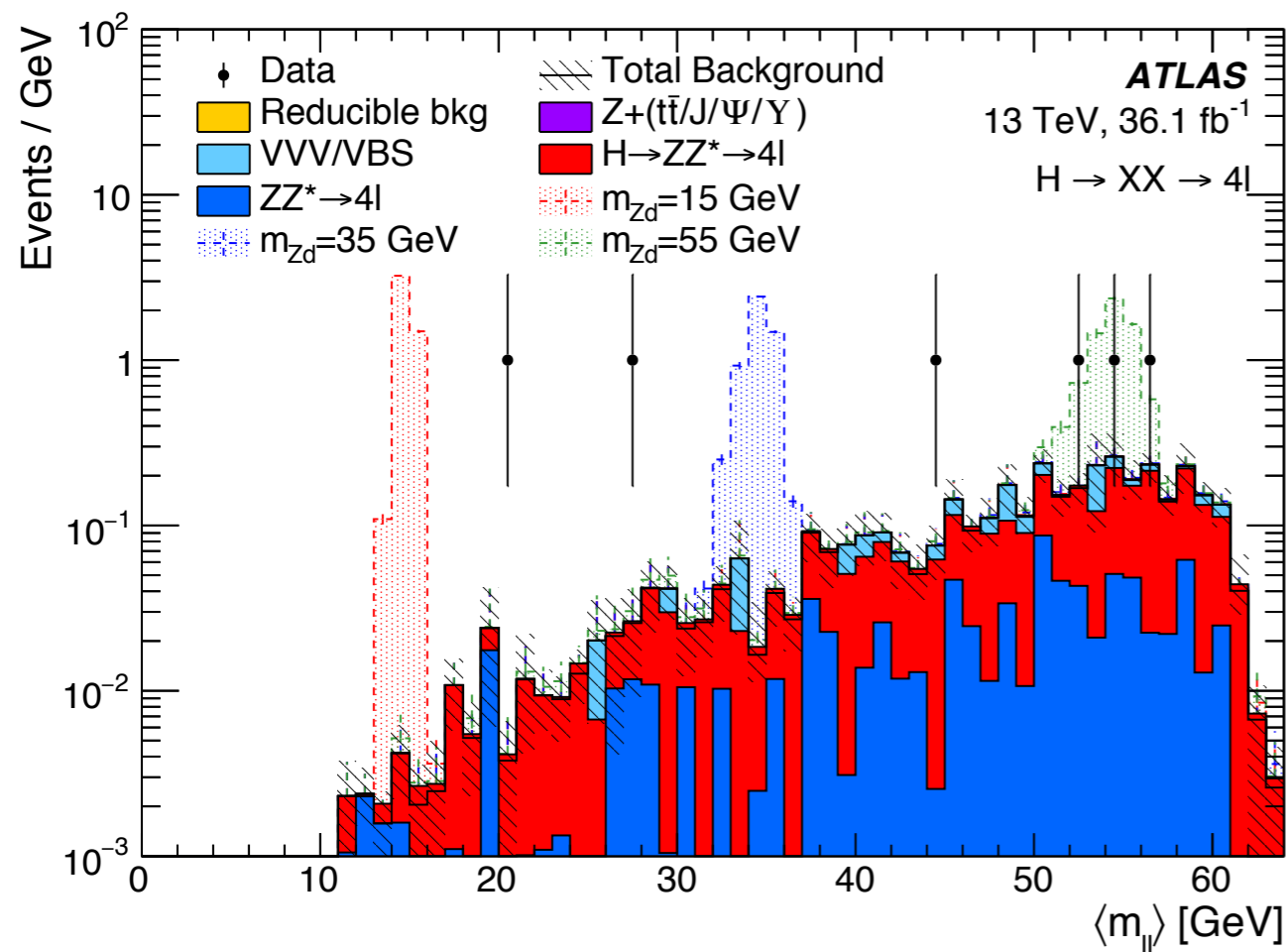

see talks by E.Reynolds, A.E.Dumitriu
and S.Somalwar (parallel)

Searches for Dilepton Resonances

High mass searches use $\sim 100 \text{ fb}^{-1}$ limits beyond 4-5 TeV!

Using 2017 data

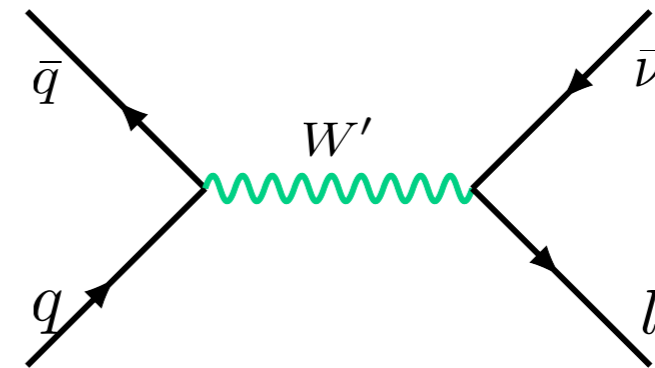
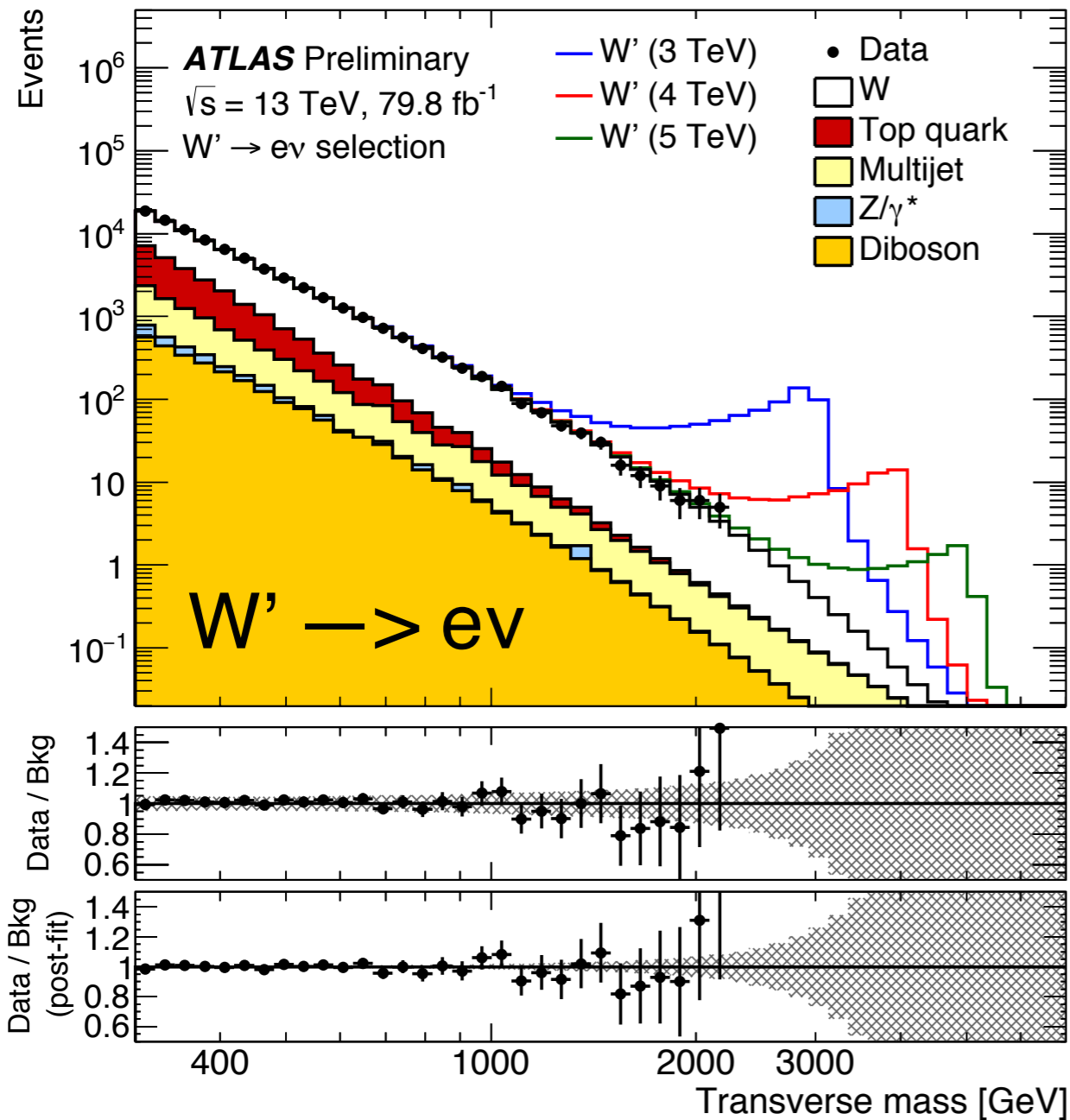

New!

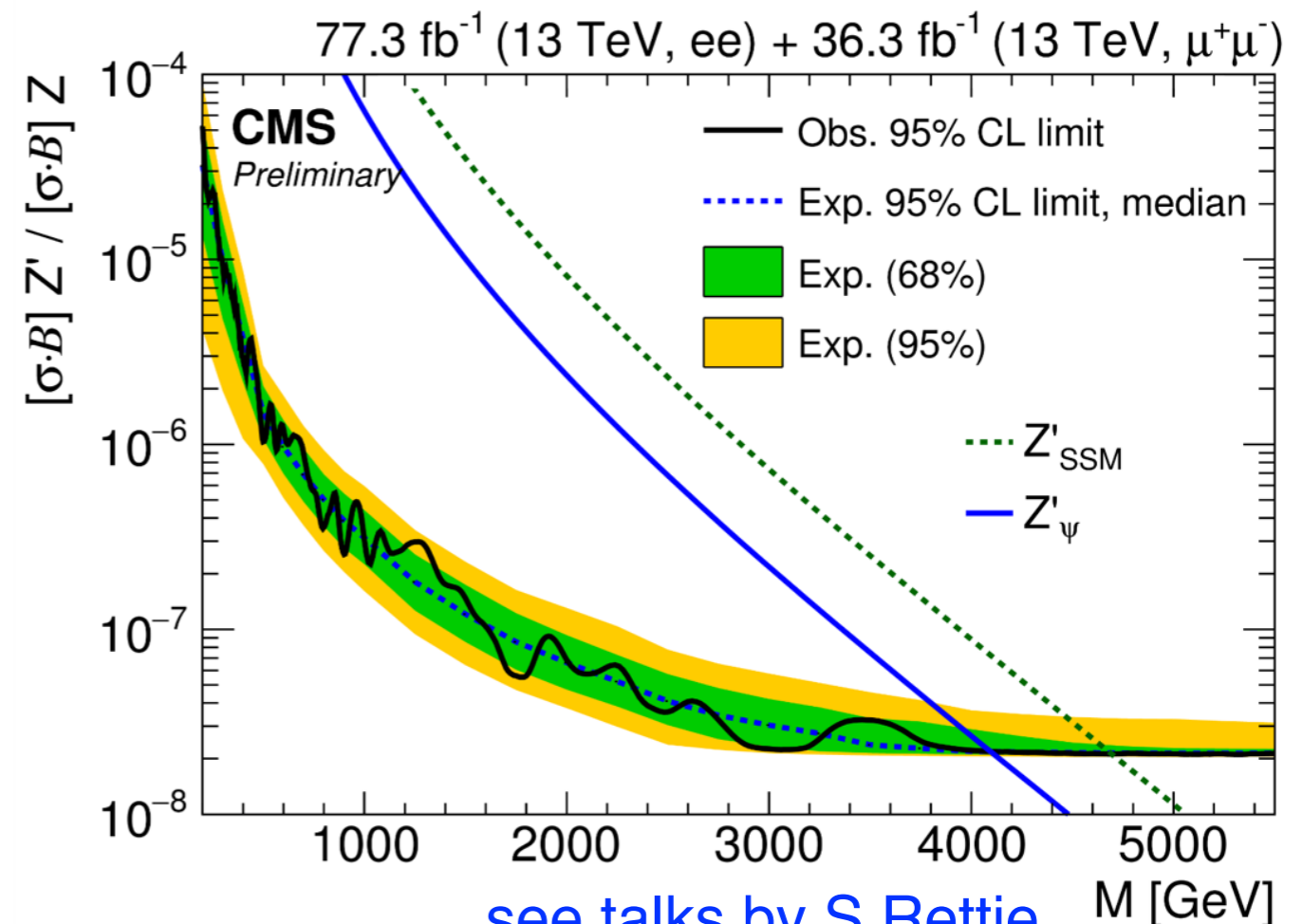

see talks by S.Rettie
 and S.Somalwar (parallel)

New Techniques - Trigger

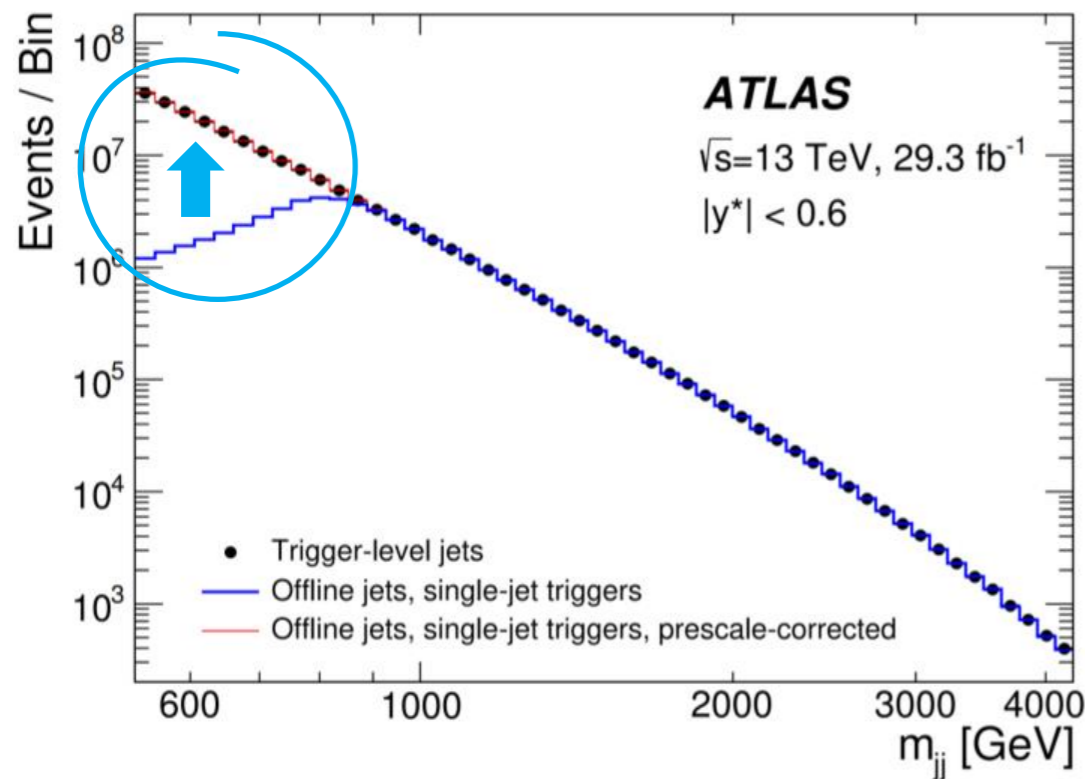
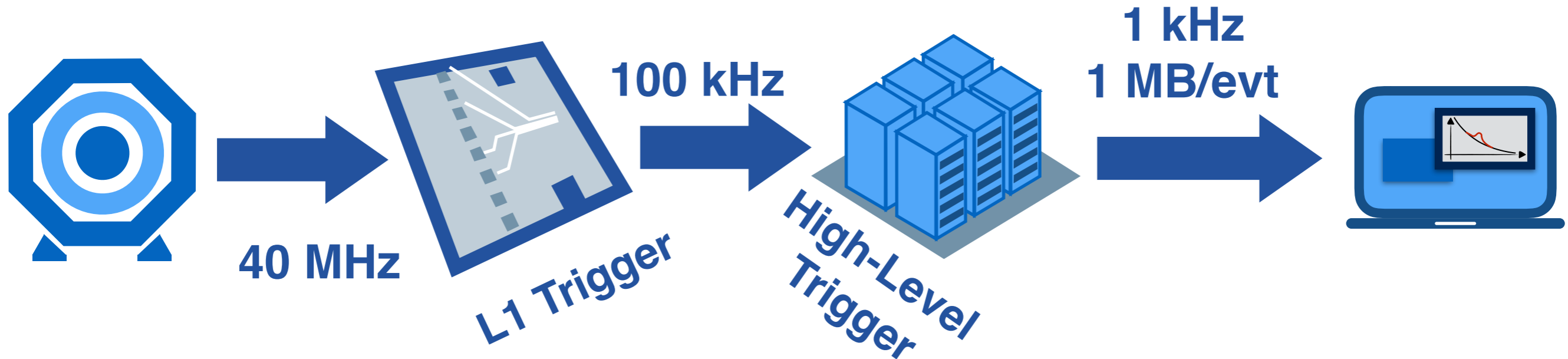

Novel “trigger-level analysis” (ATLAS) or “scouting” (CMS) allows to probe lower mass

see talks by P.Mcnamara and J.Duarte (parallel)

Dijet Resonance Searches

see talks by P.Mcnamara
and J.Duarte (parallel)

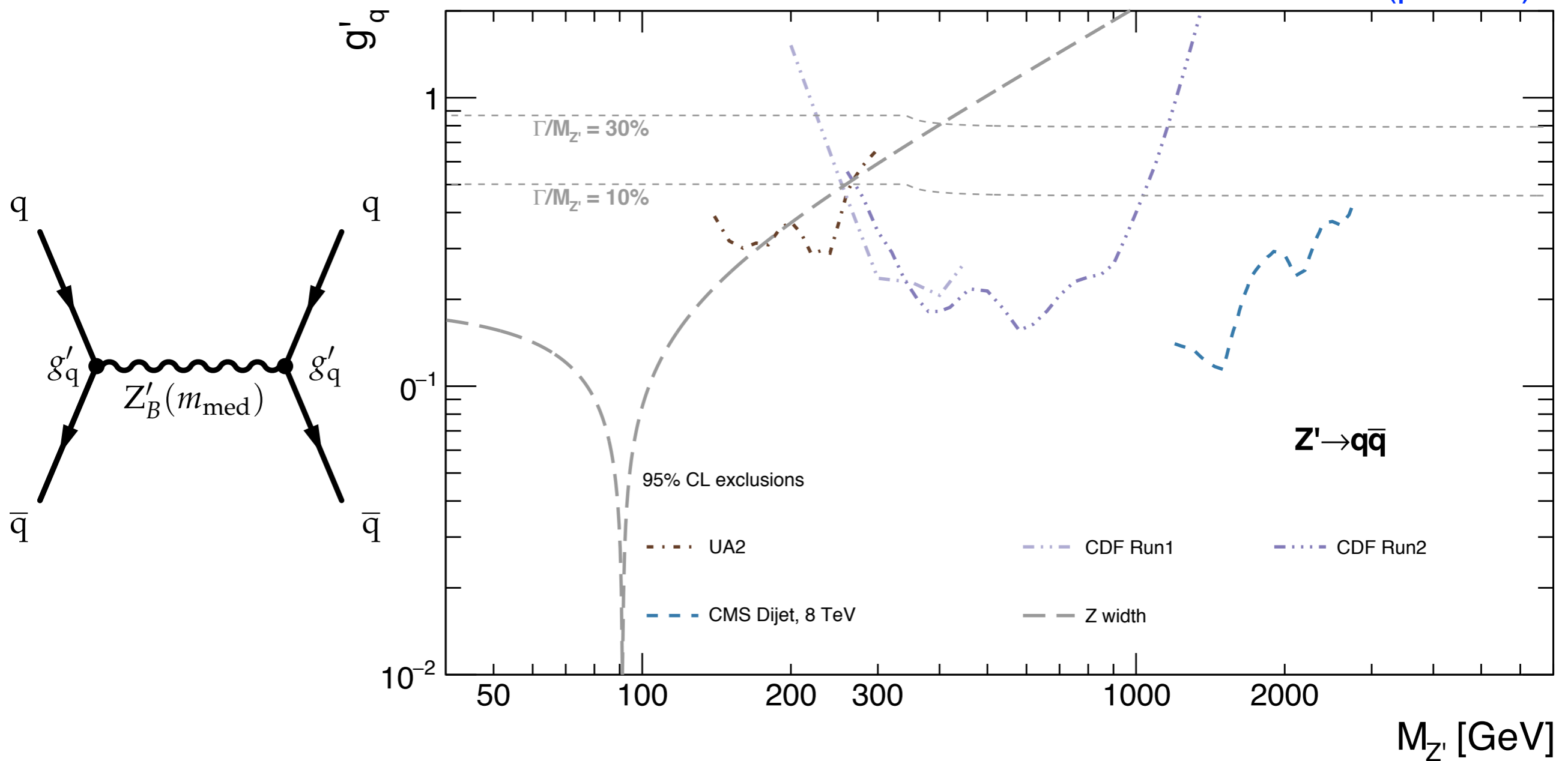

Status after 8 TeV searches at the LHC

Dijet Resonance Searches

see talks by P.Mcnamara
and J.Duarte (parallel)

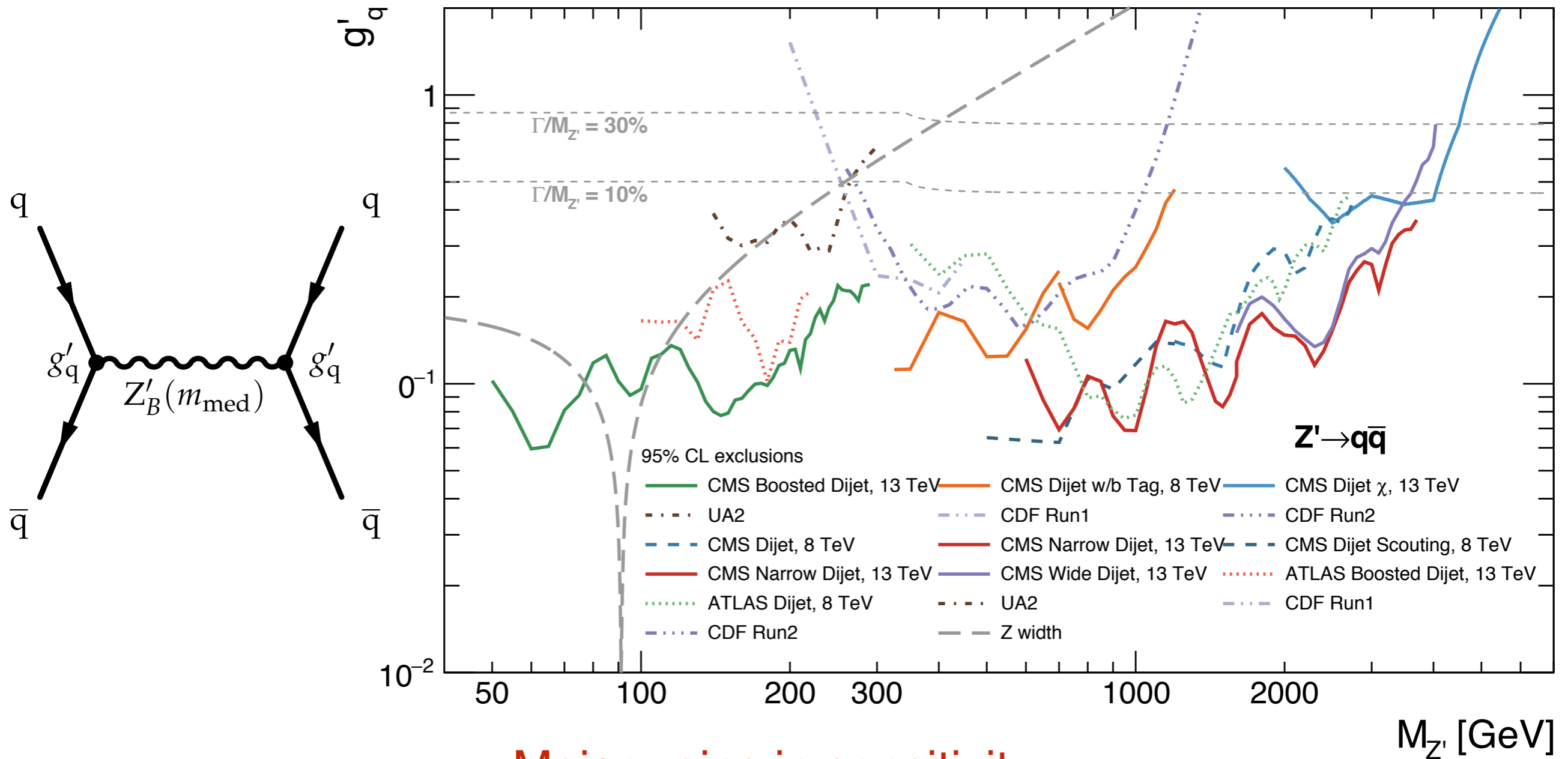

Major gains in sensitivity

Also take advantage of ISR, dedicated b-tagging triggers

Dark Matter Searches at the LHC

Major program of searches for Dark Matter at the LHC

Direct searches for DM \rightarrow Mono-X signatures, searches for new dark mediators

see talks by Y.K Kim and S.Narayanan (parallel)

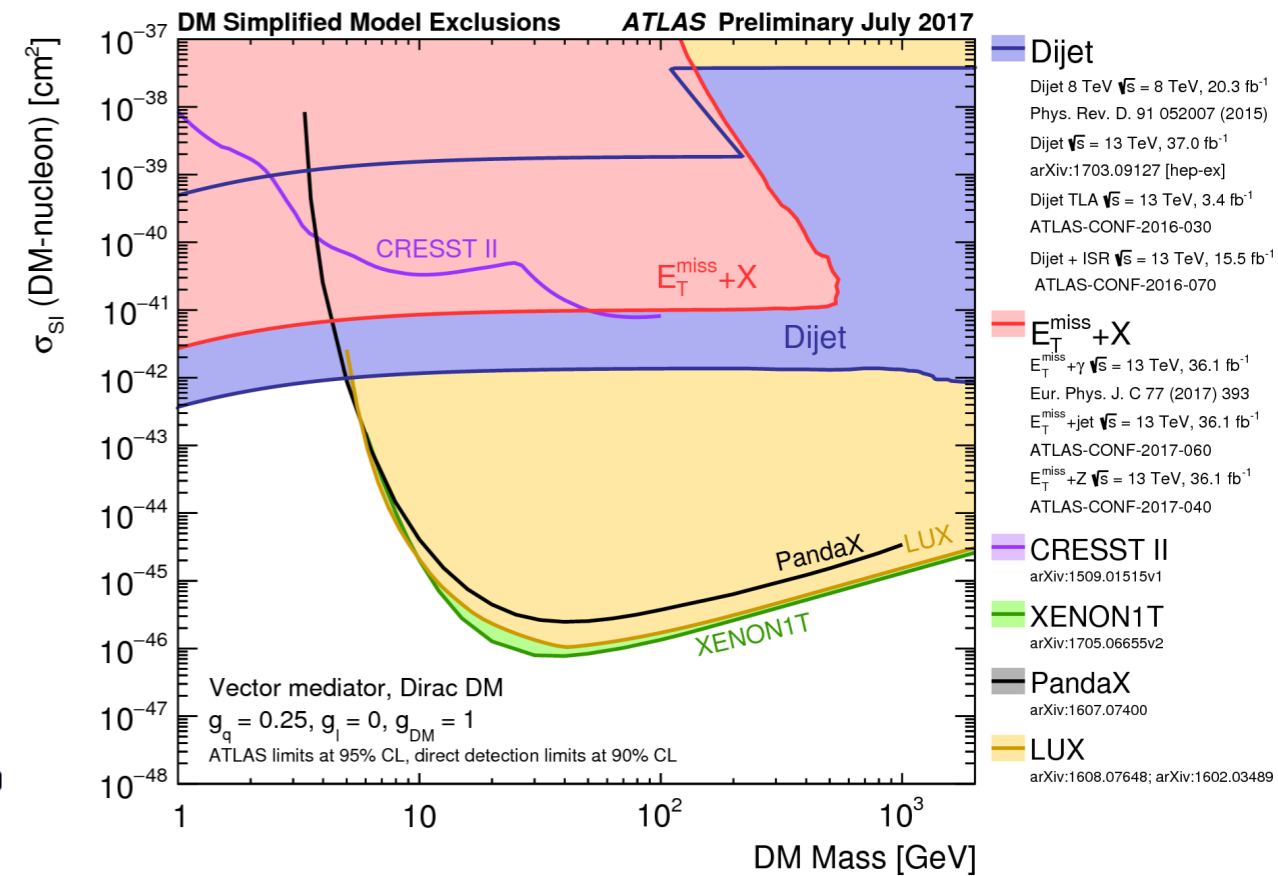
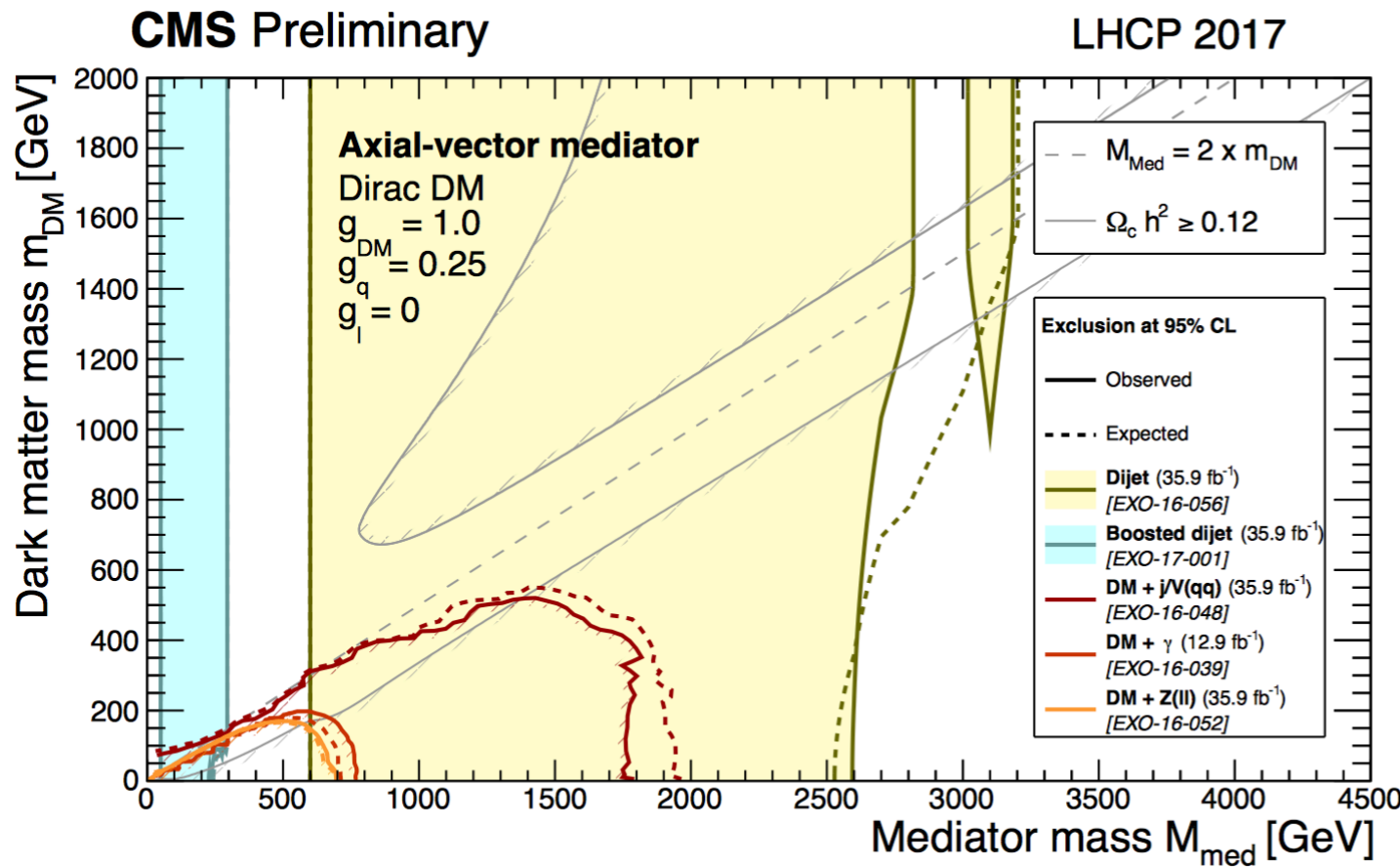

LHC searches complementary to direct searches, providing improved sensitivity to low DM masses

Looking Ahead at the LHC

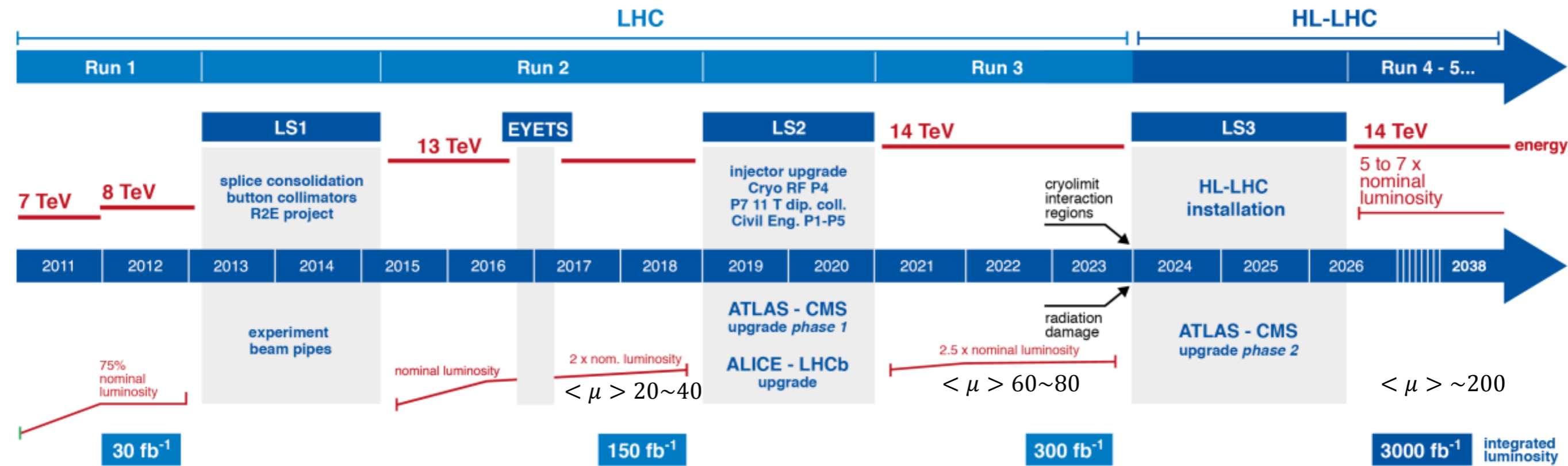

Detector upgrades to take advantage of increased luminosity in HL-LHC

Higgs and SM precision measurements

Searches for new phenomena

see talks by O.Cerri, P.Liu,
I.Dutta, B.Lefebvre (parallel)

The HL-LHC Environment

see talk by
O.Cerri (parallel)

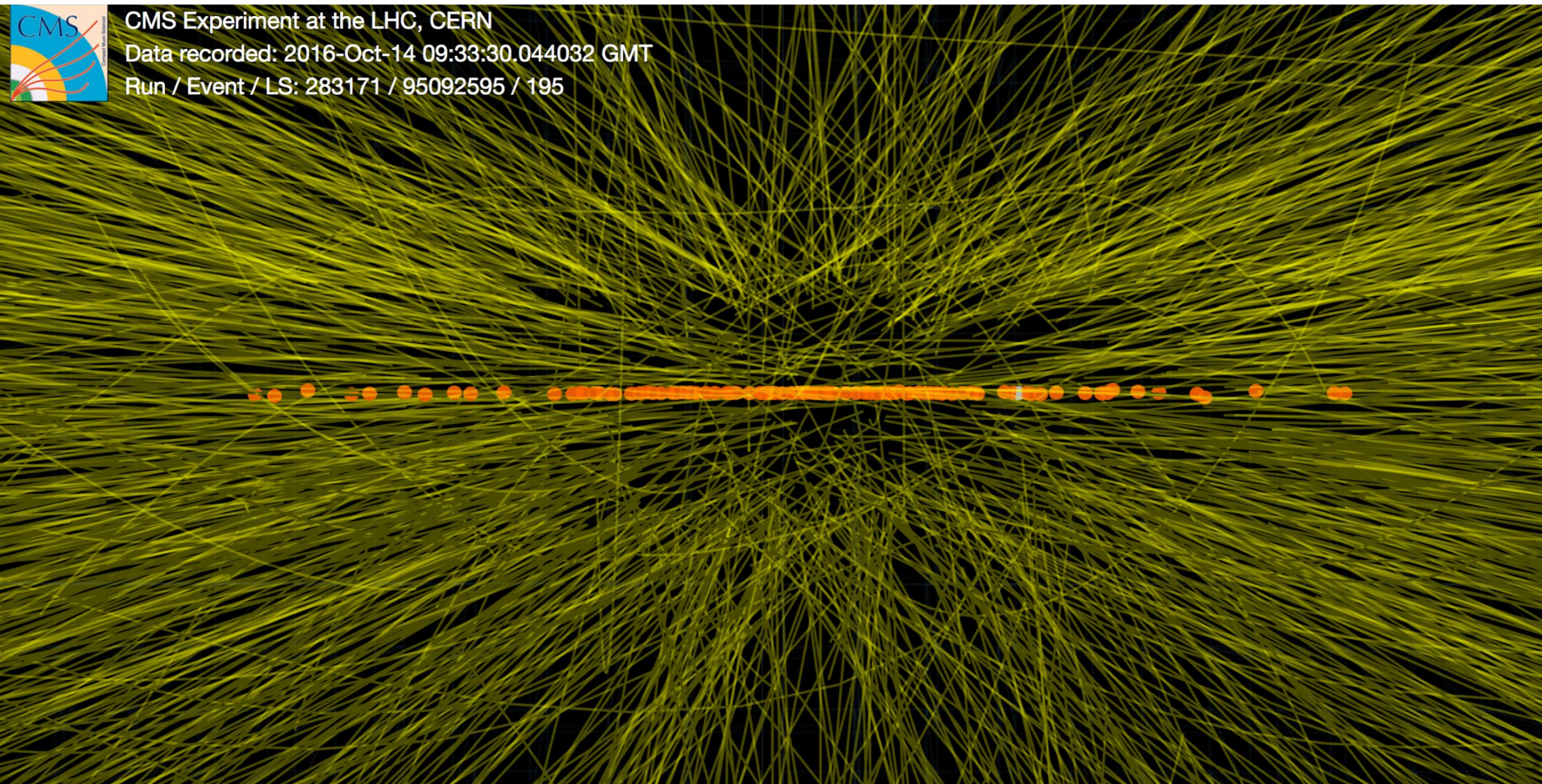

Event with 130 reconstructed vertices
Expected to increase to ~ 200 in HL-LHC

Timing Detectors

see talks by
O.Cerri and I. Dutta
(parallel)

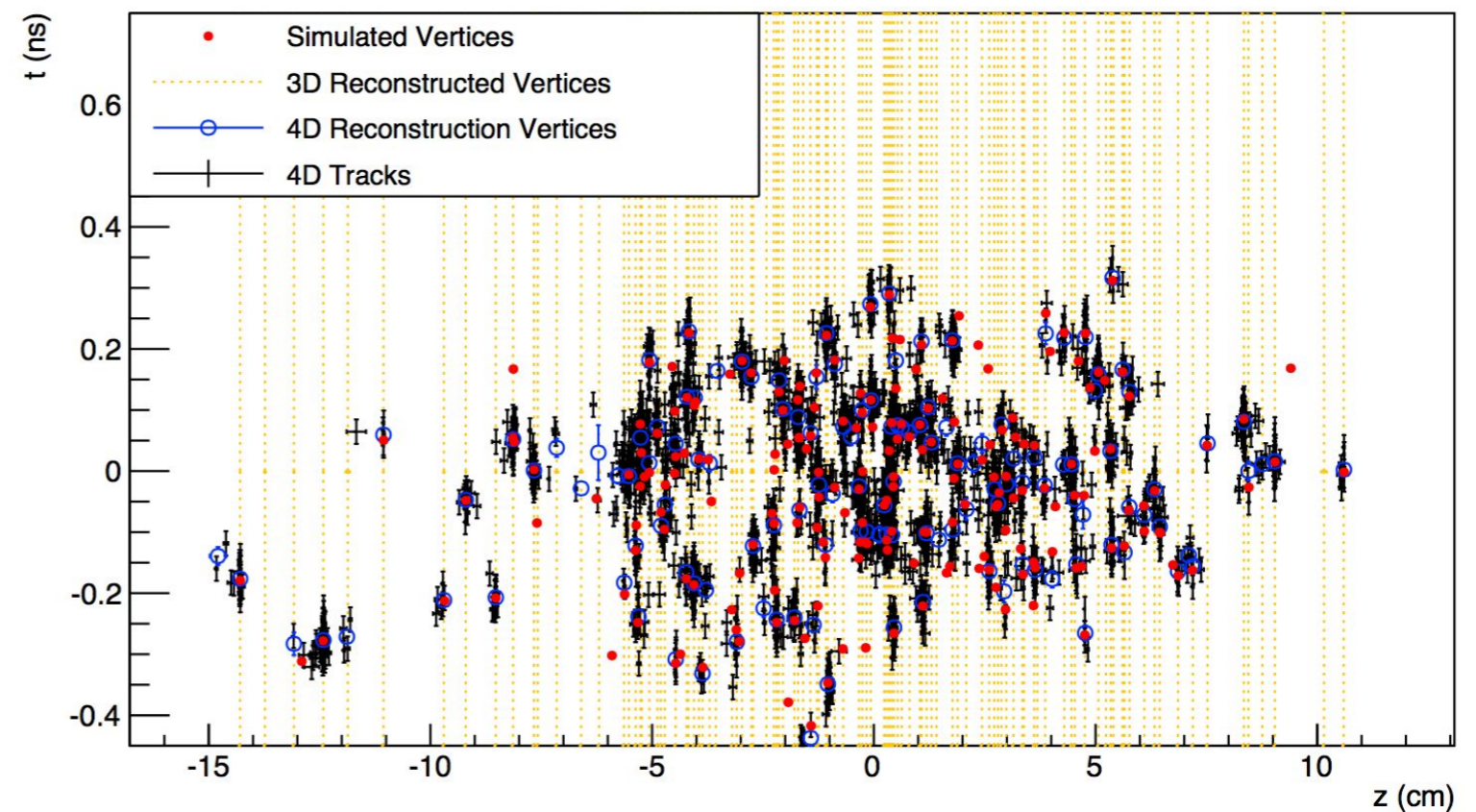
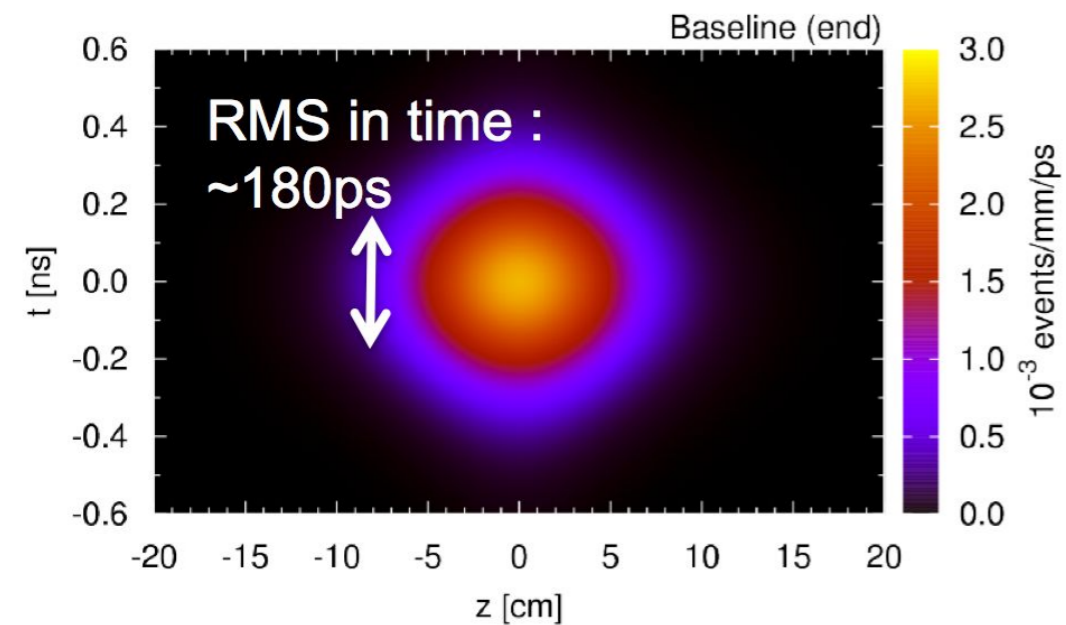

Target timing precision ~30ps

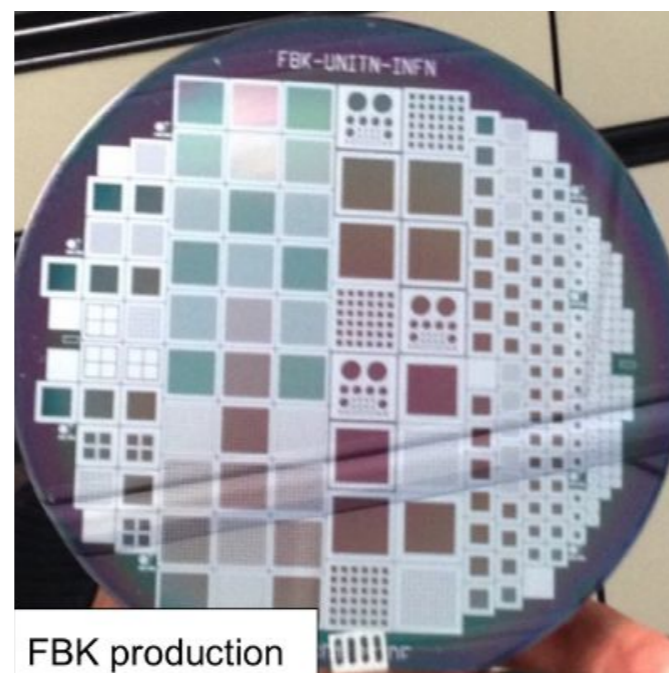

- Major increase in efficiency for Higgs program at CMS
 - $H \rightarrow ZZ^* \rightarrow 4\ell \sim 26\%$
 - $HH \rightarrow \gamma\gamma bb \sim 22\%$

Theory talks

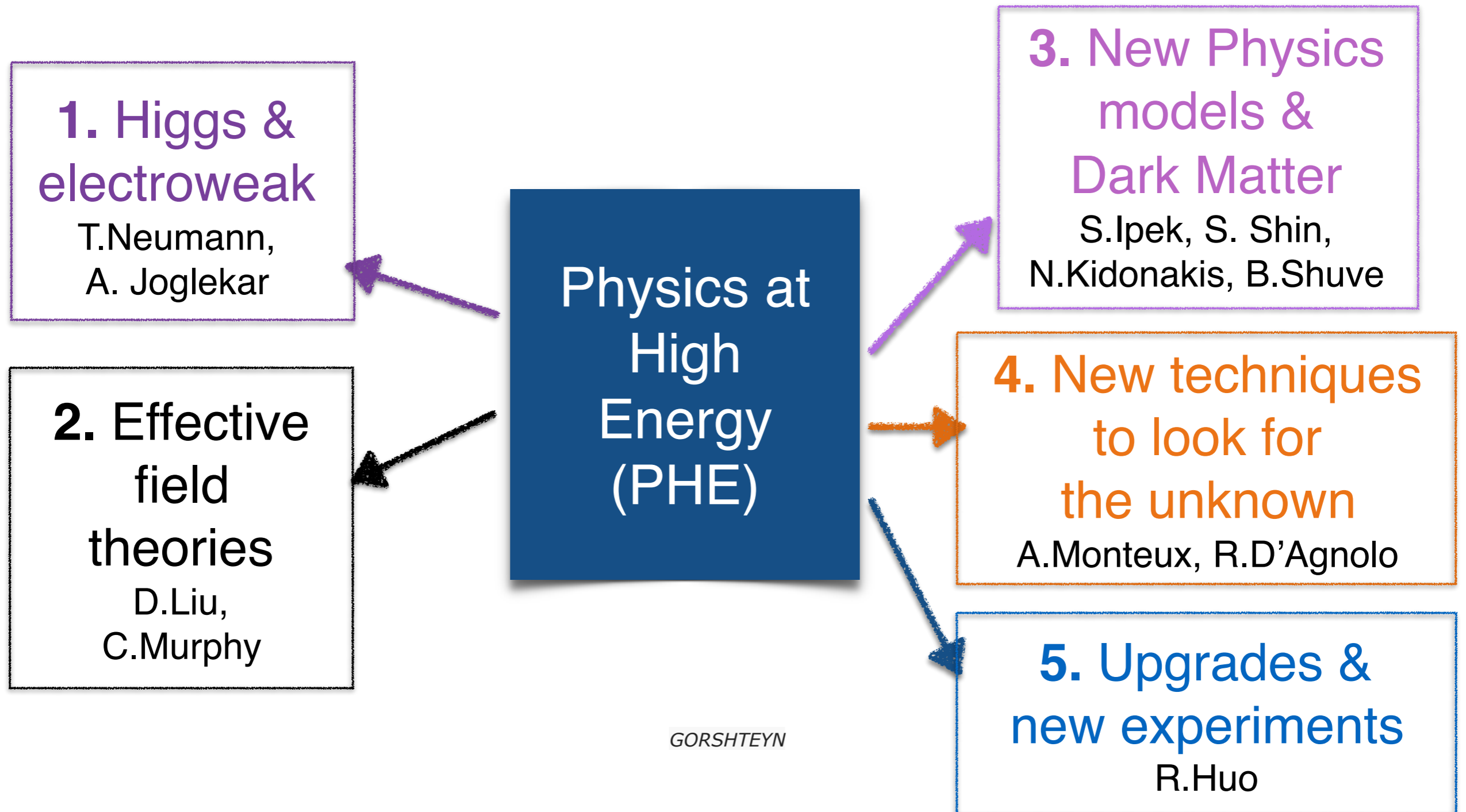

+ joint sessions with Dark Matter & Tests of Symmetries and the Electroweak Interaction (M. Gorshteyn)

Higgs and electroweak, precision

With the Large Hadron Collider (LHC) **discovery of the Higgs boson** in 2012, a new era of particle physics has started

➔ Precision determination of the Higgs properties

Theory predictions have to become more and more accurate to keep up with the more accurate measurements

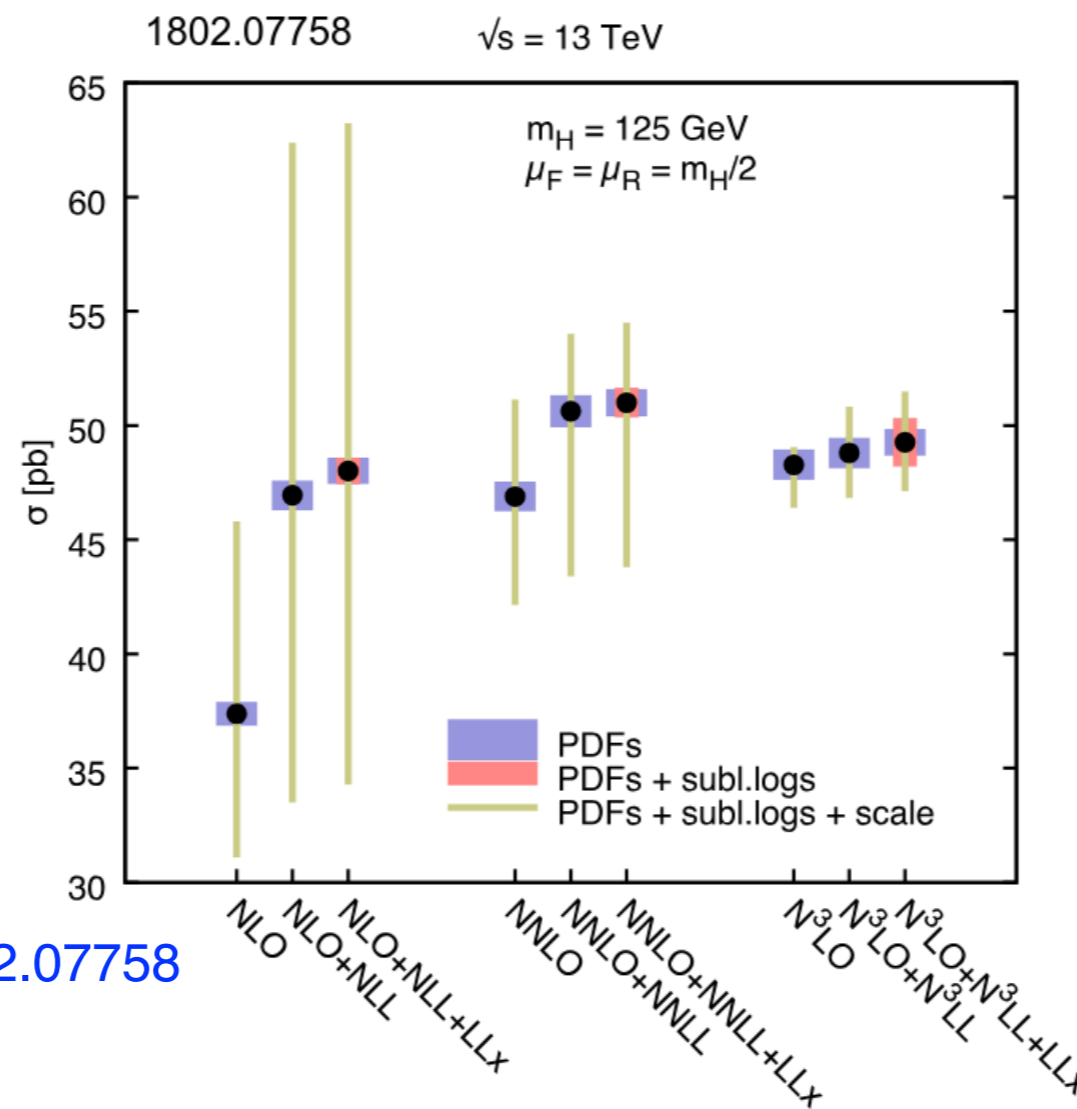

great progress of
theory calculations

see talks by
S. Dawson (plenary)
T. Neumann (parallel)

Bonvini, Marzani, 1802.07758

Higgs and electroweak, new processes

With the Large Hadron Collider (LHC) **discovery of the Higgs boson** in 2012, a new era of particle physics has started

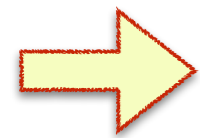

New Higgs processes to discovery

Many Higgs processes are rare and need a luminosity much larger than the presently available luminosity

Higgs and electroweak, new processes

With the Large Hadron Collider (LHC) **discovery of the Higgs boson** in 2012, a new era of particle physics has started

➔ **New Higgs processes to discovery**

Many Higgs processes are rare and need a luminosity much larger than the presently available luminosity

Example: di-Higgs production

(SM cross section ~ 2000 smaller than the single Higgs production)

- ✱ Not yet observed
- ✱ Weak available bounds
- ✱ New Physics models can affect the rate
[see talk by A.Joglekar](#)

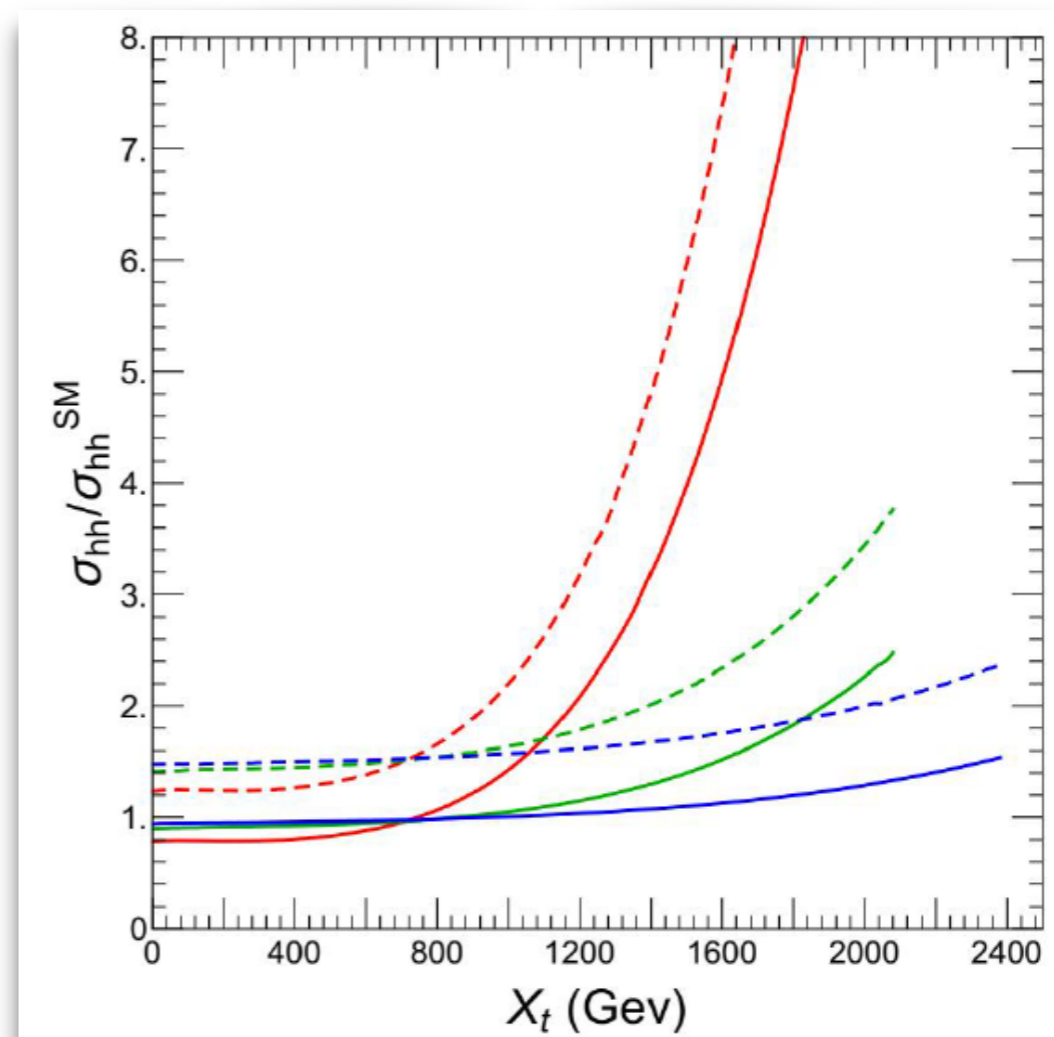

Effective field theories (EFT)

Many (theoretical and observational) motivations to study physics beyond the Standard Model

(dark matter, neutrinos, matter-anti matter asymmetry, flavor, ...)

If the new physics (NP) particle is beyond the LHC reach, it can still be detected through its effects on SM processes that the LHC measures precisely

The LHC is also a precision machine!

Effective field theories (EFT)

Many (theoretical and observational) motivations to study physics beyond the Standard Model

(dark matter, neutrinos, matter-anti matter asymmetry, flavor, ...)

If the new physics (NP) particle is beyond the LHC reach, it can still be detected through its effects on SM processes that the LHC measures precisely

The LHC is also a precision machine!

$$\mathcal{L}_{\text{SMEFT}} \supset \mathcal{L}_{\text{SM}} + \sum_i \frac{C_i}{\Lambda_i^2} \mathcal{O}_i$$

operator of dimension 6
only containing SM particles

Scale of NP

see talk by
D.Liu, C.Murphy

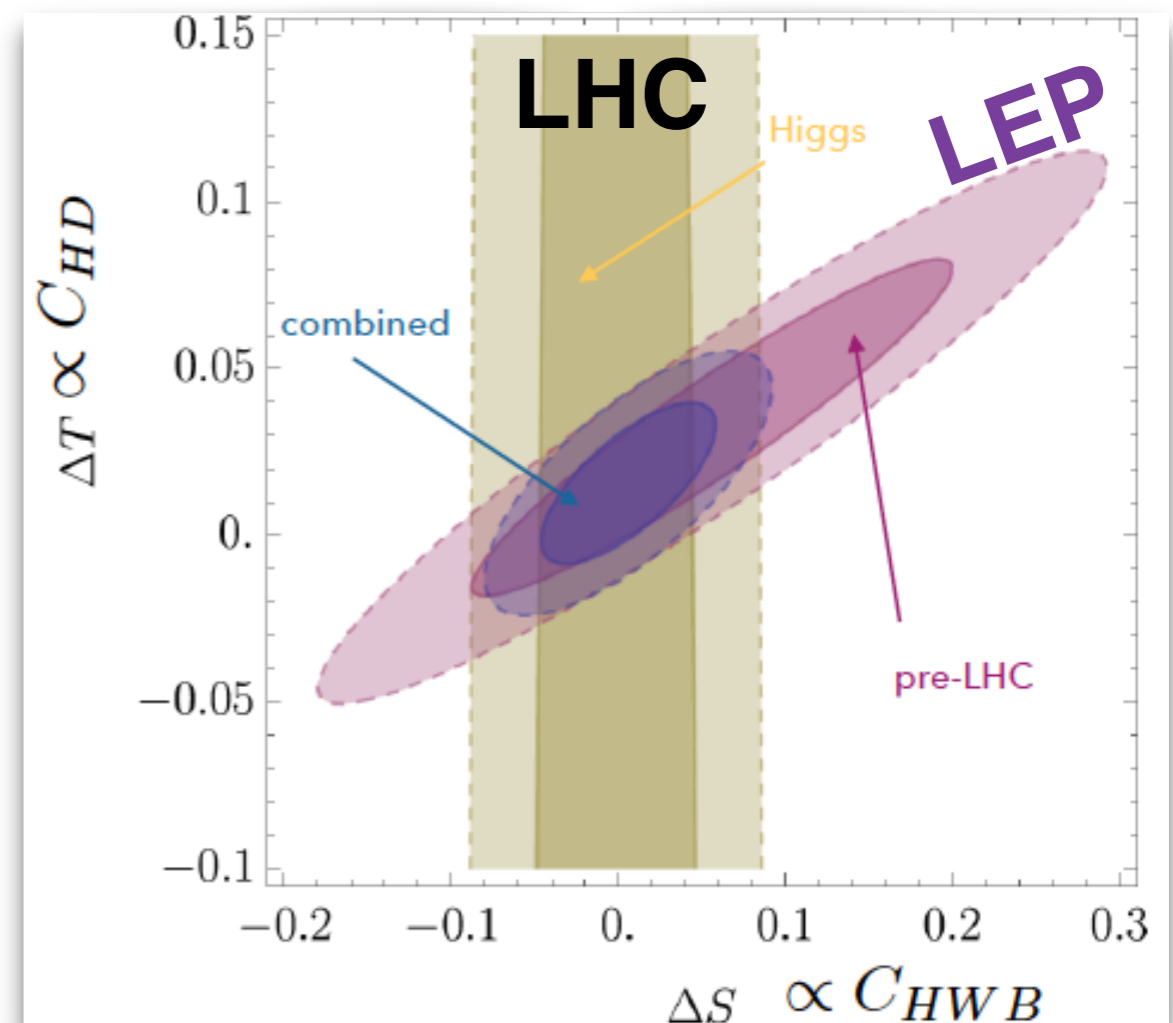

New Physics particles

Many open questions:

1. Is the Higgs the only source of EWSB? Are there new Higgs bosons?

Models with new Higgs bosons

(charged Higgs bosons, talk by N. Kidonakis; neutral Higgs bosons talk by S. Shin) with new phenomenology to explore

2. What is the origin of neutrino masses?

many theories of neutrino mass generation can be tested at the LHC

Example:

inverse see-saw with SUSY pseudo-Dirac Binors

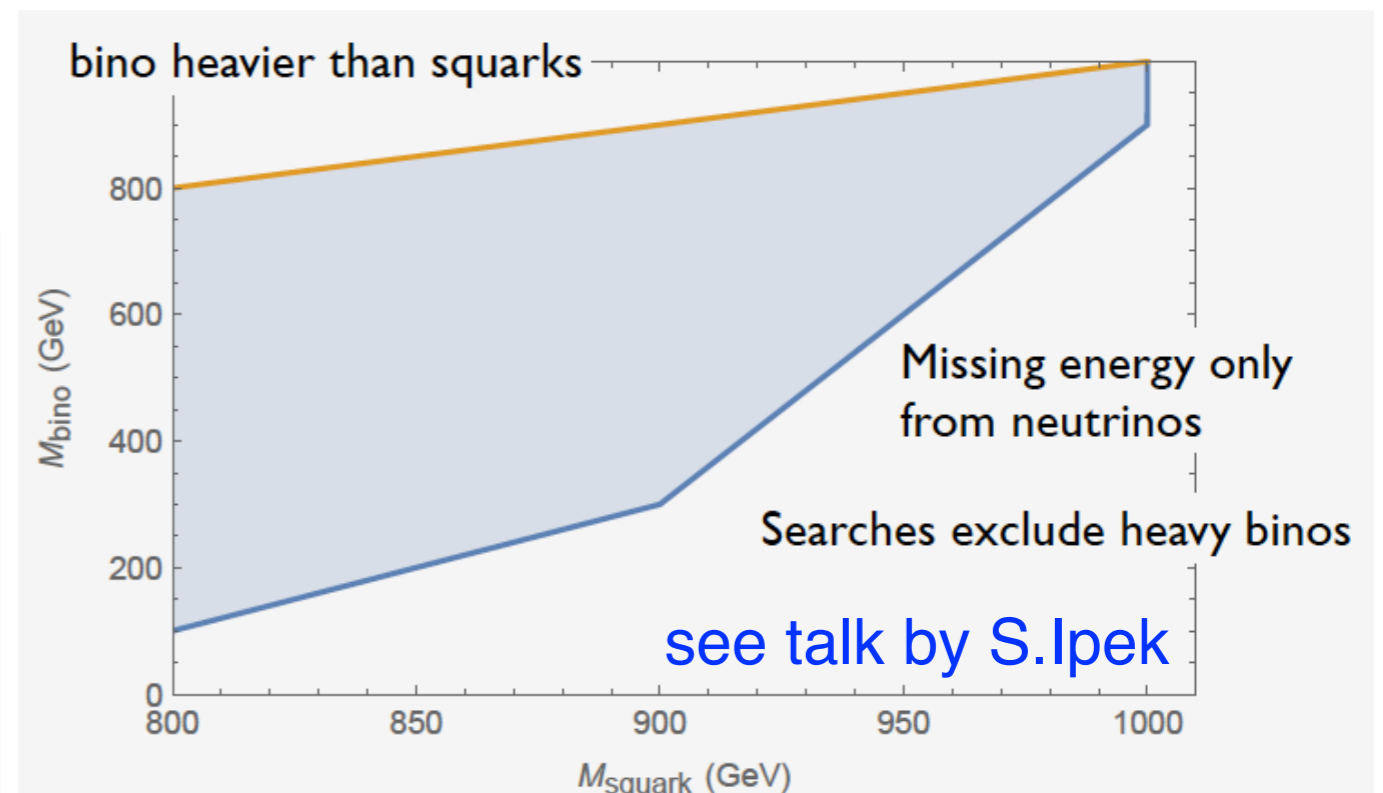
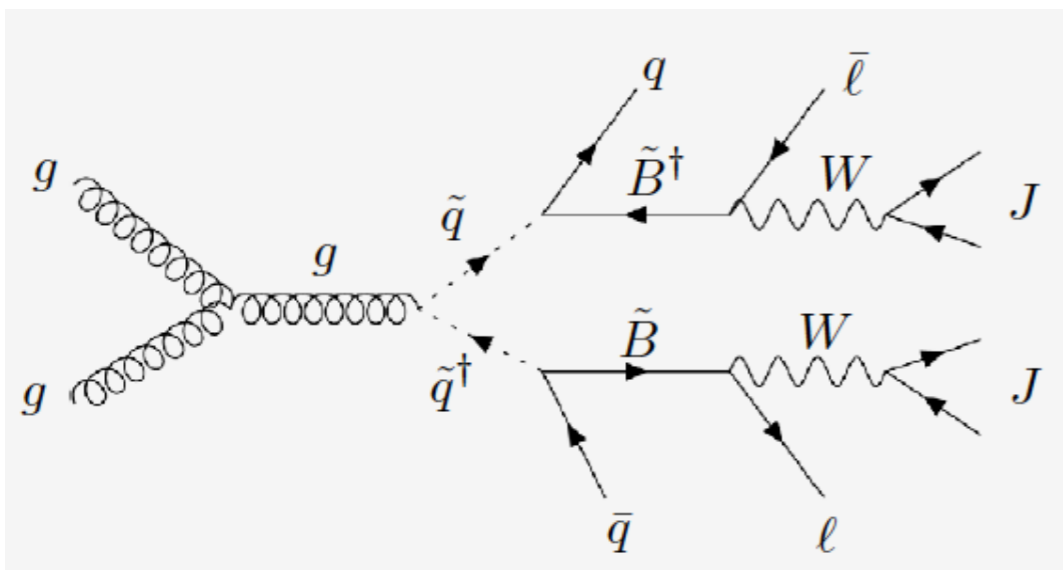

New Physics particles (at high mass)

Many open questions:

1. Is the Higgs the only source of EWSB? Are there new Higgs bosons?

Models with new Higgs bosons

(charged Higgs bosons, talk by N. Kidonakis; neutral Higgs bosons talk by S. Shin) with new phenomenology to explore

2. What is the origin of neutrino masses?

many theories of neutrino mass generation can be tested at the LHC

Example:

inverse see-saw with
SUSY pseudo-Dirac Binos

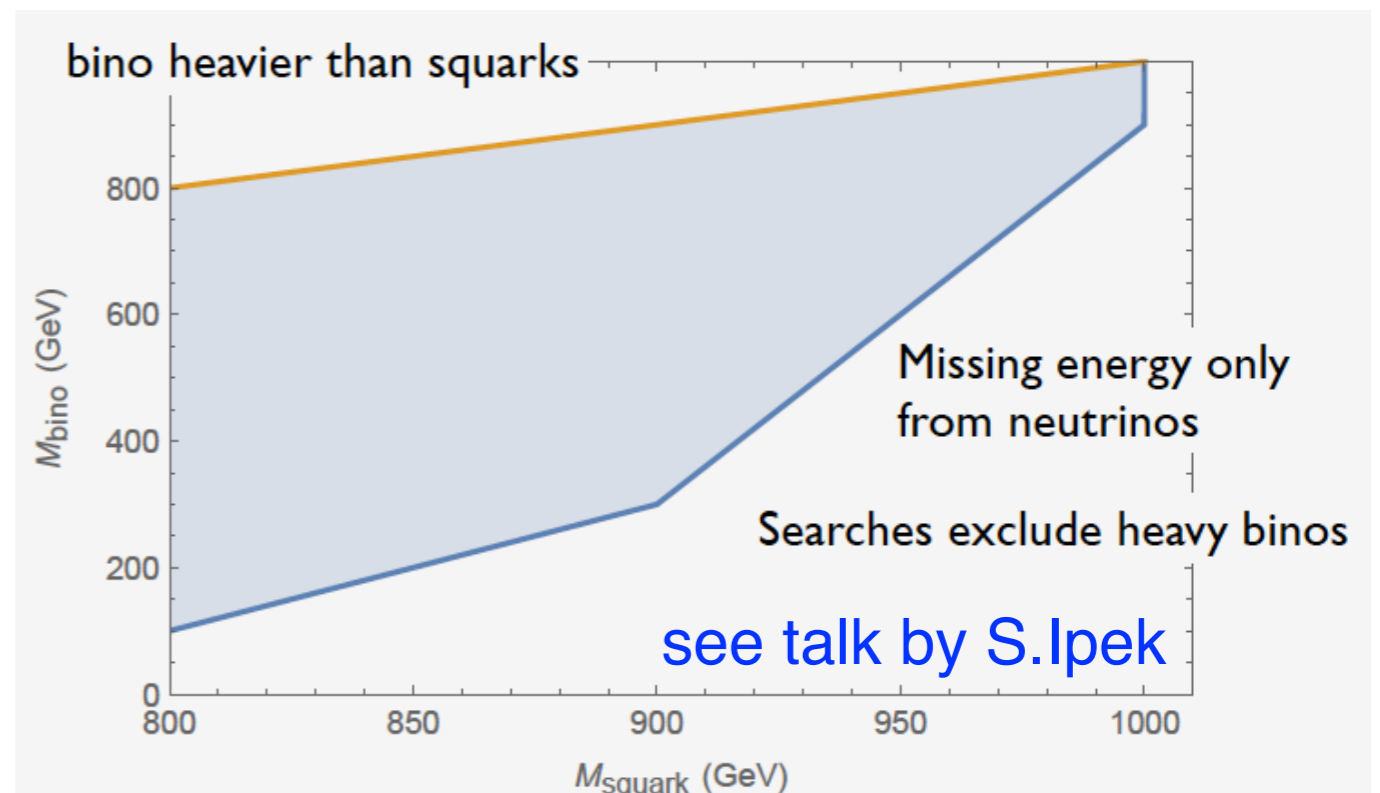
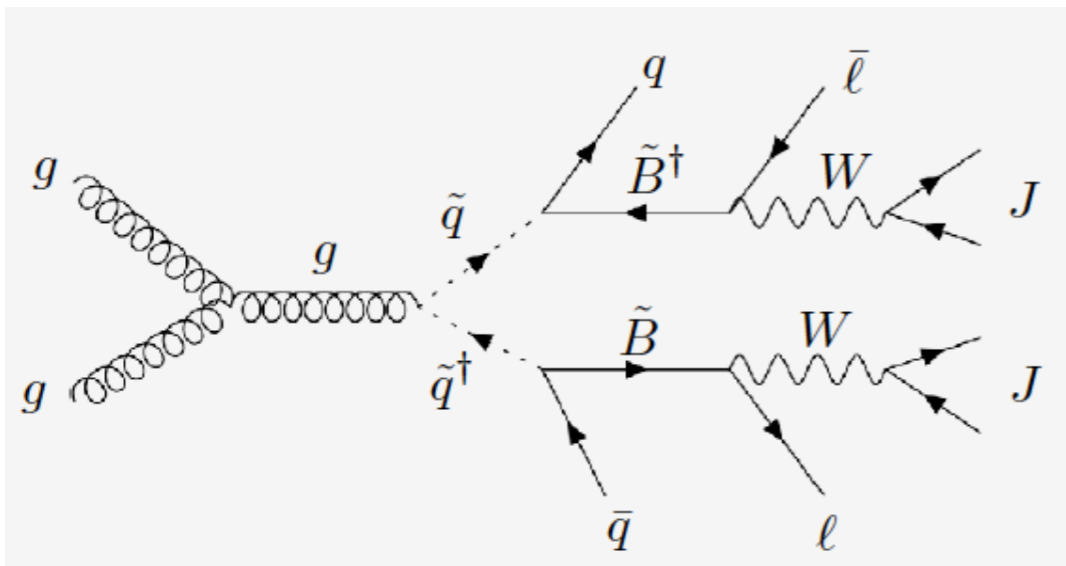

New Physics particles (at low mass)

The LHC will have reach to more and more massive particles

At the same time, **we should not leave holes in the search for light (< 100 GeV) particles!**

Many models are only very weakly probed. **Dark sectors**

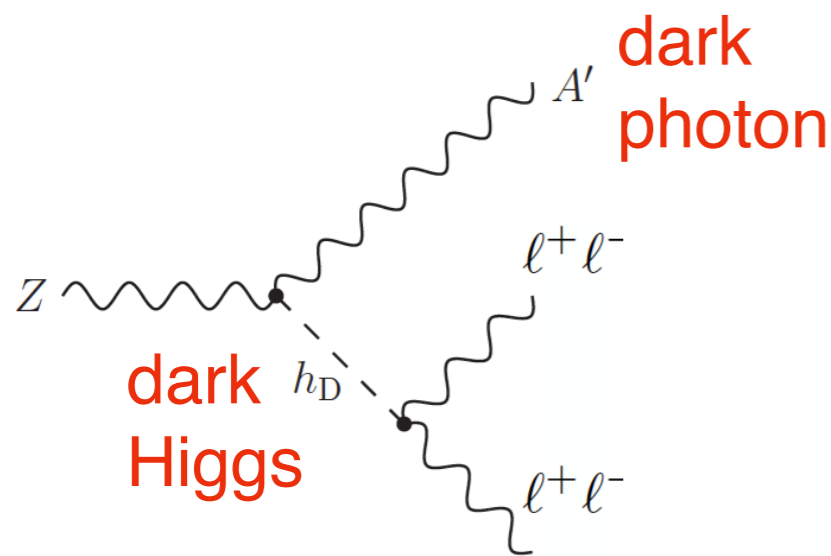

see talk by B.Shuve

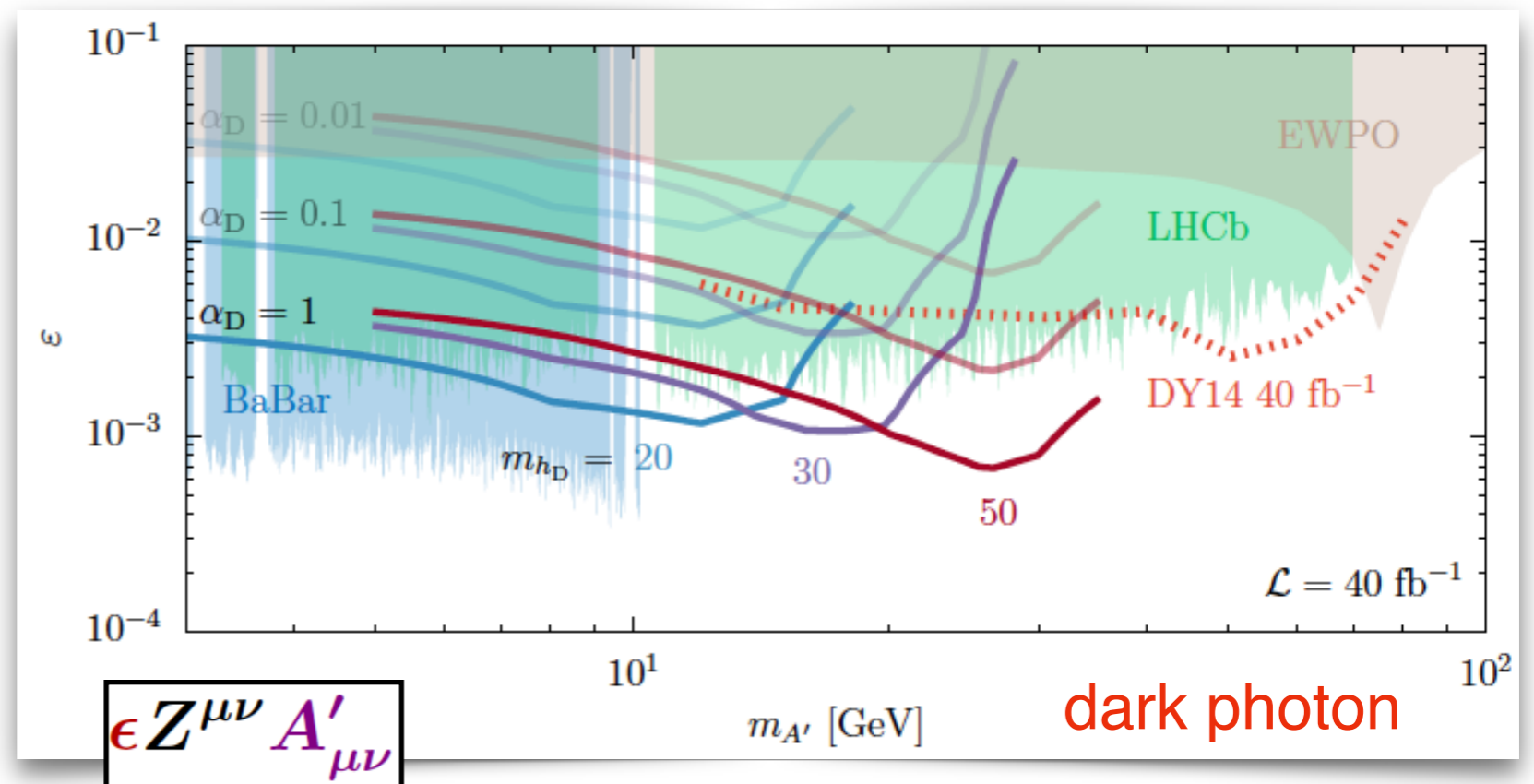

Challenges (soft objects, needs for low threshold triggers, ...) and opportunities for the LHC

Complementarity with high intensity and precision experiments

New techniques to look for the unknown

Two interesting talks on ways to spot anomalies in data (if compared to the SM prediction) in a model independent way

1. Talk by A.Monteux “A true signal will usually populate multiple neighboring signal regions, while background fluctuations are more often confined to individual bins.”

Technique: aggregate together nearby bins in a rectangle R and compute the likelihood of observing a deviation as large as observed in the data, assuming New Physics only contributes to that rectangle.

2. Talk by R.D’Agnolo: use of neural network

Technique: learn the data distribution & check if it is different from the reference one (the Standard Model)

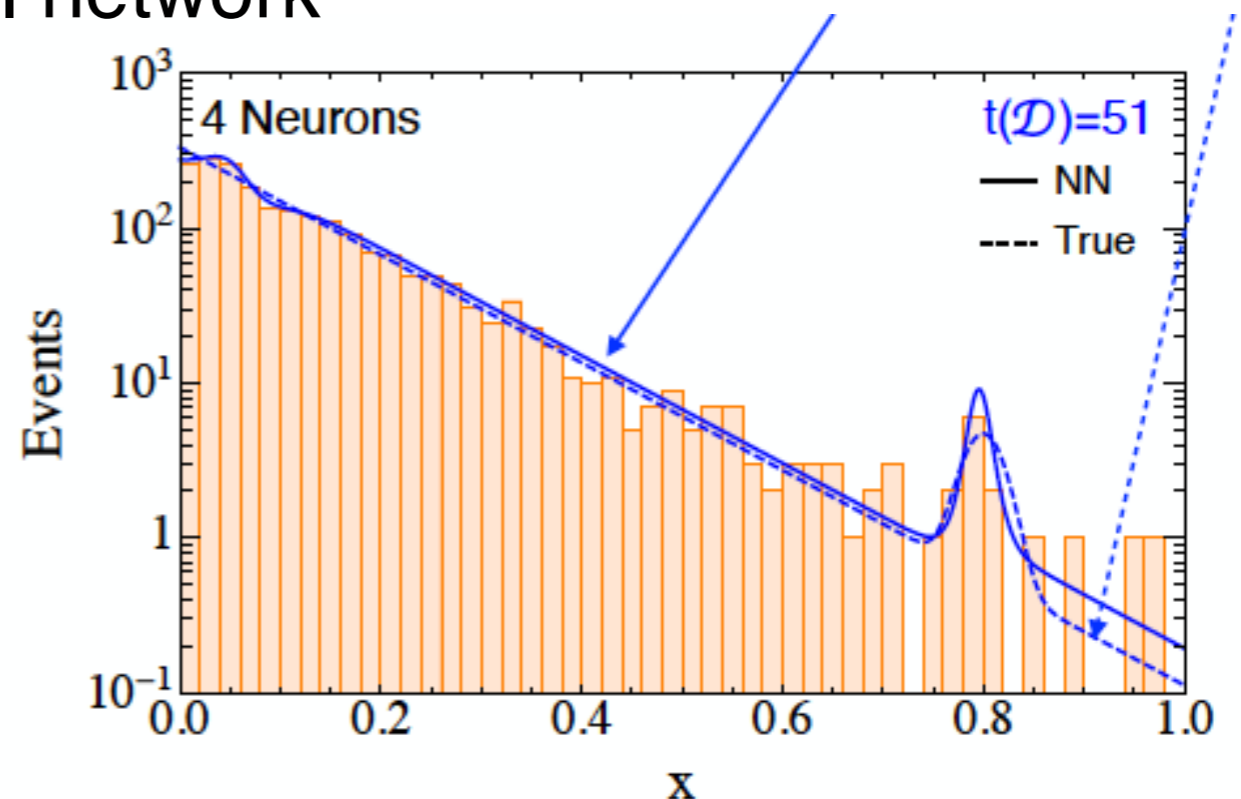

To conclude...

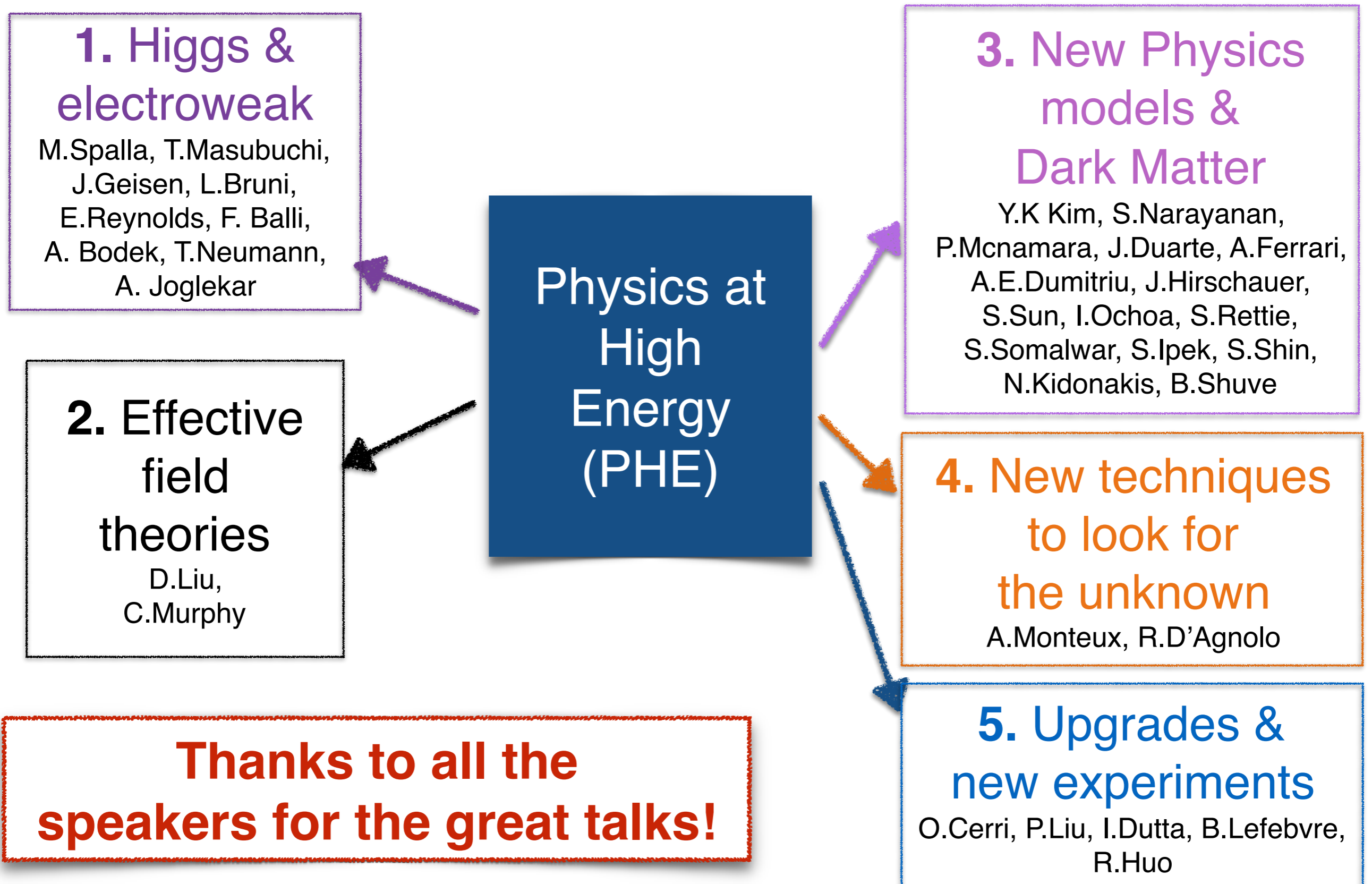

EXTRA

Diboson Searches

see talks by I.Ochoa
and S.Somalwar (parallel)

Substructure techniques (for jets, b-tagging) used for maximizing sensitivity to boosted topologies, large mass range

Includes using the Higgs as a discovery tool (“Higgs-tagging”)

New!

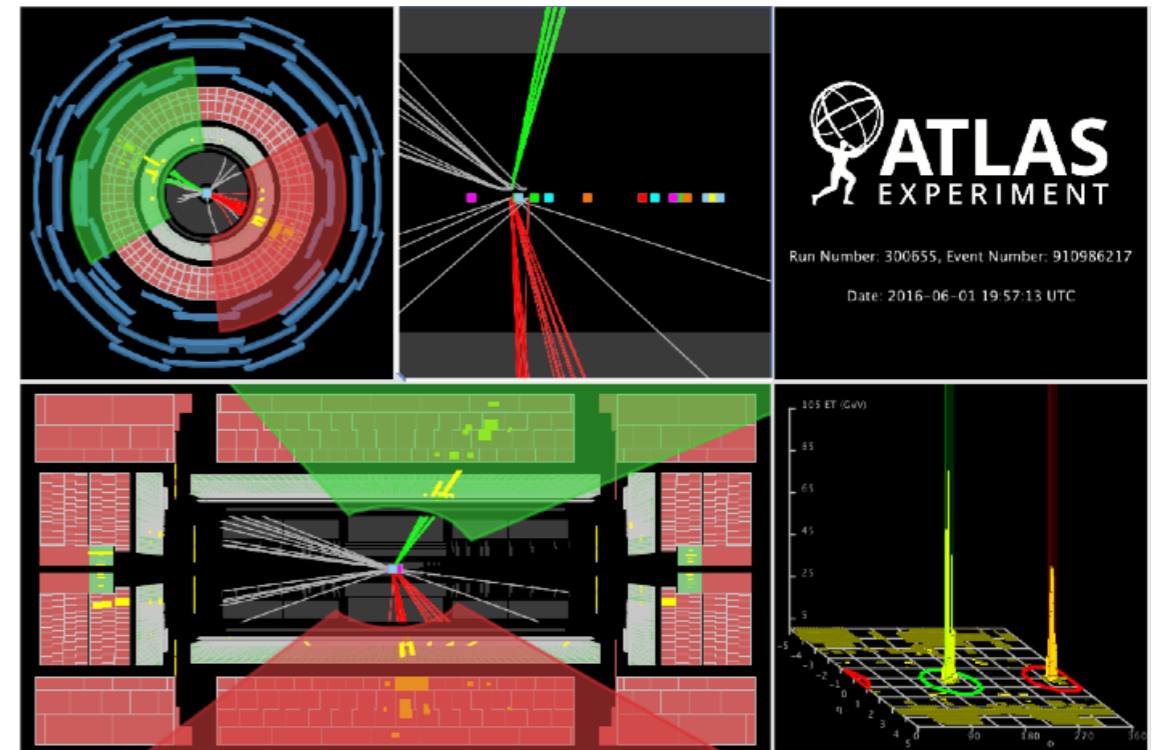
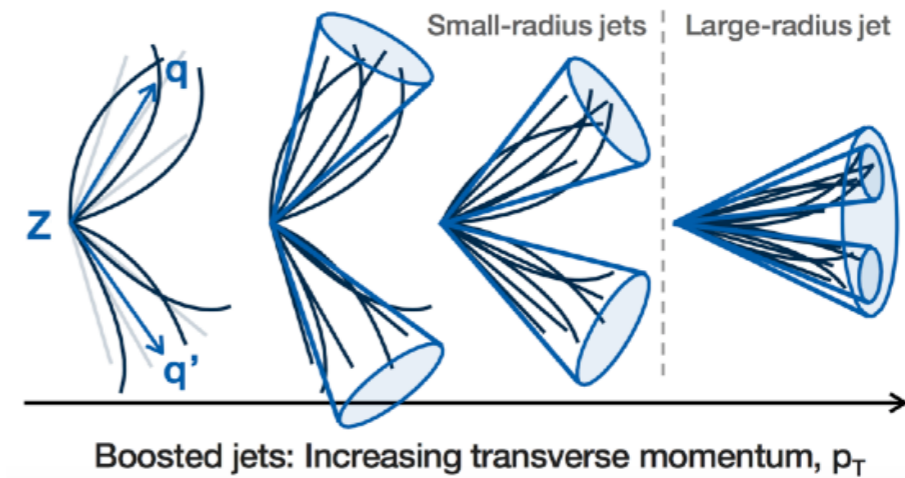
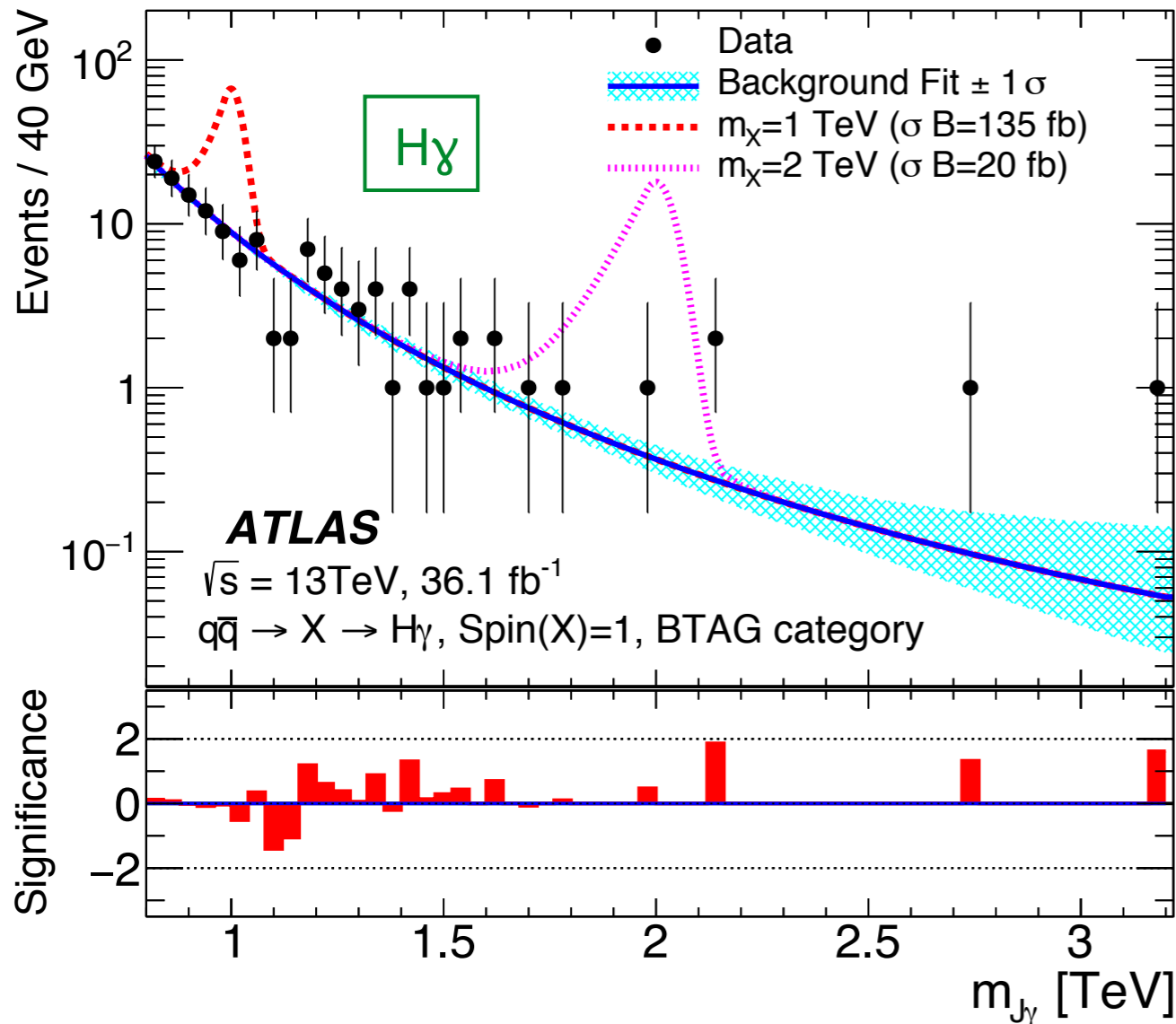

SUSY Searches at the LHC

see talks by J.Hirschauer and S.Sun (parallel)

- Searches extending to more challenging scenarios
 - Low rate processes
 - Difficult regions of phase space
 - More complex signals \rightarrow long lived scenarios

